

# Declaration of Conformity

## We, Manufacturer

ZIPPY TECHNOLOGY CORP.  
10F, No.50, MIN MINQUAN RD.  
XINDIAN DIST, NEW TAIPEI CITY  
TAIWAN, R.O.C.

declare that the product  
(description of the apparatus, system, installation to which it refers)

### SWITCHING POWER SUPPLY

#### MRW-6400P

is in conformity with  
(reference to the specification under which conformity is declared)  
in accordance with 2004/108/EC-EMC Directive

- EN 55022 : 2010  
Information technology equipment  
-Radio disturbance characteristics  
-Limits and methods of measurement
- EN 55024 : 2010  
Information technology equipment  
-Immunity characteristics  
-Limits and methods of measurement
- EN 61000-4-2 : 2009 Criteria B  
Electrostatic discharge  
requirements "ESD"
- EN 61000-4-3 : 2006+A1:2007+A2:2010  
Criteria A  
Radiated, radio frequency  
electromagnetic field
- EN 61000-4-4 : 2004+A1:2010 Criteria B  
Electrical fast transient  
requirements "EFT"
- EN 61000-4-5 : 2006 Criteria B  
Surge Immunity  
requirements
- EN 61000-4-6 : 2009 Criteria A  
Conducted Immunity
- EN 61000-4-8 : 2010 Criteria A  
Power Frequency Magnetic  
Field Immunity
- EN 61000-4-11 : 2004  
Dip Criteria B  
Interruptions Criteria C  
Voltage Dip, interruptions  
Immunity requirements
- EN 61000-3-2 : 2006+A1:2009+A2:2009  
Harmonic current  
requirements
- EN 61000-3-3 : 2008  
Voltage fluctuations  
and flicker  
requirements

#### Manufacturer

Date : NOV,29,2013

Signature: Jeff Huang

Name: ZIPPY

#### Test-Lab

Date : NOV,29,2013

Signature: Karen

Name: ZIPPY

APPLICATION FOR CERTIFICATION  
ON Behalf Of  
ZIPPY TECHNOLOGY CORP.  
SWITCHING POWER SUPPLY

Model# : **MRW-6400P**

FCCID:N/A

PREPARED FOR :

ZIPPY TECHNOLOGY CORP.  
10F., No.50, MINQUAN RD.,  
XINDIAN DIST., NEW TAIPEI CITY  
TAIWAN, R.O.C

REPORT BY :

ZIPPY TECHNOLOGY CORP.  
10F., No.50, MINQUAN RD.,  
XINDIAN DIST., NEW TAIPEI CITY  
TAIWAN, R.O.C  
TEL : (02)2918-8512  
FAX : (02)2913-4969

## TABLE OF CONTENTS

Description	Page
<b>1. Test Report Certification</b> .....	5
<b>2. General Information</b> .....	6
2.1 Production Description.....	6
2.2 Tested System Details.....	7
2.2.1 Resistor Load.....	7
2.3 Test Methodology.....	7
2.4 Test Facility.....	7
<b>3. Electronic-Magnetic Interference Test</b> .....	8
3.1. Conducted Power Line Test.....	8
3.1.1 Test Equipments.....	8
3.1.2 Block Diagram of Test Setup.....	8
3.1.3 Conducted Powerline Emission Limit.....	9
3.1.4 EUT Configuration on Measurement.....	9
3.1.5 EUT Exercise Software.....	9
3.1.6 Conducted Emission Data.....	9
3.2. Radiation Emission Test .....	15
3.2.1 Test Equipment .....	15
3.2.2 Test Setup .....	15
3.2.3 Radiated Emission Limited .....	16
3.2.4 EUT Configuration .....	17
3.2.5 Operating Condition of EUT .....	17
3.2.6 Radiated Emission Data .....	17
3.2.7 Test Photo and Setup .....	21
<b>4. ESD Measurement</b> .....	22
4.1 Test Equipments.....	22
4.2 Test Setup.....	22
4.2.1 Block Diagram of Connections between EUT and simulators.....	22
4.2.2 Test Setup of EUT.....	22
4.3 Severity Levels.....	23
4.4 EUT Operating Condition.....	23
4.5 Test Procedure.....	23
4.6 Test Method.....	23
4.7 Test Result.....	24

## TABLE OF CONTENTS

Description	Page
<b>5. Radiated Susceptibility Measurement</b> .....	25
5.1 Test Equipment.....	25
5.2 Block Diagram of Test Setup.....	25
5.3 Severity Levels.....	26
5.4 EUT Operating Condition.....	26
5.5 Test procedure.....	26
5.6 Test Method.....	26
5.7 Test Result.....	27
<b>6. Electrical Fast Transient/Burst Measurement</b> .....	28
6.1 Test Equipment .....	28
6.2 Block Diagram of Test Setup.....	28
6.3 Severity Levels .....	28
6.4 EUT Operating Condition.....	29
6.5 Test procedure .....	29
6.6 Test Method.....	29
6.7 Test Result.....	30
<b>7. Harmonic Current Requirements</b> .....	31
<b>8. Voltage Fluctuation and Filcker Test</b> .....	33
<b>9. Surge Immunity Test</b> .....	34
<b>10. Conducted Immunity Test</b> .....	35
<b>11. Voltage Dip,interruptions Immunity Test</b> .....	36
<b>12. Power Frequency Magnetic Field (PFM) Immunity Test</b> .....	37
<b>13. Photographs</b> .....	38
<b>14. EMI Reduction method during compliance Testing</b> .....	44
Appendix A Circuit diagram, block diagram, User Manual	
Appendix B Doc	

## 1. Test Report Certification

Applicant : ZIPPY TECHNOLOGY CORP.

Manufacturer : ZIPPY TECHNOLOGY CORP.

EUT Description : Switching Power Supply

(A) FCC ID : N/A

(B) Model No. : MRW-6400P

(C) Serial No. : N/A

(D) Power Supply : 115Vac/60Hz,230Vac/50Hz

MEASUREMENT PROCEDURE USED :

EN 55024 RULES

EN 55022 RULES

THE DEVICE DESCRIBED ABOVE WAS TESTED BY ZIPPY SHIN JIUH CORP. TO DETERMINE THE SEVERITY LEVELS THE DEVICE CAN ENDURE AND ITS PERFORMANCE CRITERION.

THE MEASUREMENT RESULTS ARE CONTAINED IN THIS TEST REPORT AND ZIPPY SHIN JIUH CORP. IS ASSUMED FULL RESPONSIBILITY FOR THE ACCURACY AND COMPLETENESS OF THESE MEASUREMENT.

ALSO, THIS REPORT SHOWS THAT THE EUT TO BE TECHNICALLY COMPLIANT WITH THE EN STANDARD.

Test Dated : NOV,29,2013

Test Engineer : Karen

Approve & Authorized Signer : Jeff Huang

## 2. General Information

### 2.1 Production Description

Description : Switching Power Supply

Model Number : **MRW-6400P**

Applicant : ZIPPY TECHNOLOGY CORP.

Address : 10F., No.50, MINQUAN RD.,XINDIAN DIST.,  
NEW TAIPEI CITY TAIWAN, R.O.C

FCC ID : N/A

Data Cable : N/A

PowerCord : Non-Shielded, detachable, 1.5m

## 2.2 Tested System Details

The FCC IDs for all equipment, plus descriptions of all cables used in the tested system (including inserted cards, which have grants) are:

### 2.2.1 Resistor Load

Model Number : ELECTRONIC LOAD  
Serial Number : N/A  
FCC ID : N/A  
Manufacturer : ZIPPY  
Power : 400W

## 2.3 Test Methodology

EMI Test:

Both conducted and radiated testing were performed according to the procedures in EN 55022  
Radiated testing was performed at an antenna to EUT distance of 10 meters.

EMS Test:

Performed according to procedures in EN 61000 series regulations.

## 2.4 Test Facility

ZIPPY TECHNOLOGY CORP.  
10F., No.50, MINQUAN RD.,  
XINDIAN DIST., NEW TAIPEI CITY  
TAIWAN, R.O.C

### 3. Electronic-Magnetic Interference Test

#### 3.1 Conducted Power Line Test

##### 3.1.1 TEST Equipment's

The following test equipment's are used during the conducted power line tests:

Item	Instrument	Manufacture	Type No:	Last Calibration
1	TEST RECEIVER	ROHDE & SCHWARZ	ESHS10	Mar.,2013
2	LISN	ROHDE & SCHWARZ	ENV4200	Jan.,2013
3	SHIELDED ROOM 4.0M*3.0M*3M			N/A

##### 3.1.2 Block Diagram of Test Setup

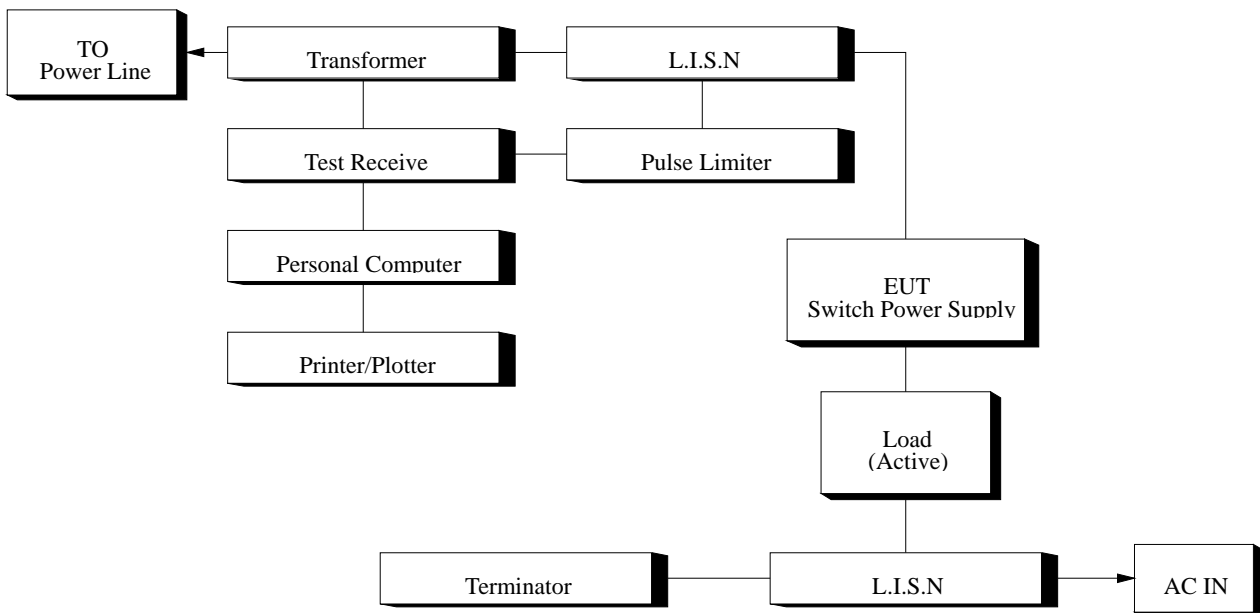



### 3.1.3 Conducted Powerline Emission Limit

Maximum RF Line Voltage dB(uV)		
Frequency	Class B	
MHz	QUASI-PEAK	AVERAGE
0.15 - 0.50	66-56	66-56
0.50 - 5.0	56	56
5.0 - 30	60	60

Remarks : In the Above Table, the tighter limit applies at the band edges.

### 3.1.4 EUT Configuration on Measurement

The equipment's which is listed 3.2 are installed on Conducted Power Line Test to meet the Commission requirement and operating in a manner which tends to maximize its emission characteristics in a normal application.

### 3.1.5 EUT Exercise Software

The EUT exercise program used during conducted testing was designed to exercise the EUT in a manner similar to a typical use. The exercise sequence is listed as below :

3.1.5.1 Setup the EUT and simulators as shown on 3.2.

3.1.5.2 Turn on the power of all equipment's.

### 3.1.6 Conducted Emission Data

The measurement range of conducted emission which is from 0.15 MHz to 30 MHz was investigated. The initial step in collecting conducted data is a spectrum analyzer peak scan of the measurement range for all the test modes. Then the worst modes were reported the following data pages.

### Conducted Emission Data

EUT : SWITCH POWER SUPPLY TEMPERATURE : 26°C

TEST MODE : MRW-6400P HUMIDITY : 65%

Frequency	Reading Level dBuV		Limites
	Line 1	Line 2	
MHz			DBuV
0.164	56.46	54.54	65.26
0.328	44.66	42.10	59.50

Remark : All readings are Quasi-Peak values.

# ZIPPY EMC LAB

## conduction test

EUT: MRW-6400P SPS  
 Manuf: ZIPPY TECH CO..LTD  
 Op Cond: FULL LOAD  
 Operator:  
 Test Spec: EN 55022-- Class B  
 Comment: Load Condition(19 20 0.5 1.2 13 2)  
 L220V

Scan Settings (3 Ranges)			Receiver Settings					
Start	Stop	Step	IF BW	Detector	M-Time	Atten	Preamp	OpRge
150kHz	500kHz	2kHz	10kHz	QP+AV	1msec	Auto	OFF	60dB
500kHz	5MHz	20kHz	10kHz	QP+AV	1msec	Auto	OFF	60dB
5MHz	30MHz	50kHz	10kHz	QP+AV	1msec	Auto	OFF	60dB

Transducer	No.	Start	Stop	Name
	1	9kHz	30MHz	CEB

Prescan Measurement: Detectors: X QP / + AV  
 Meas Time: see scan settings  
 Peaks: 8  
 Acc Margin: 25 dB

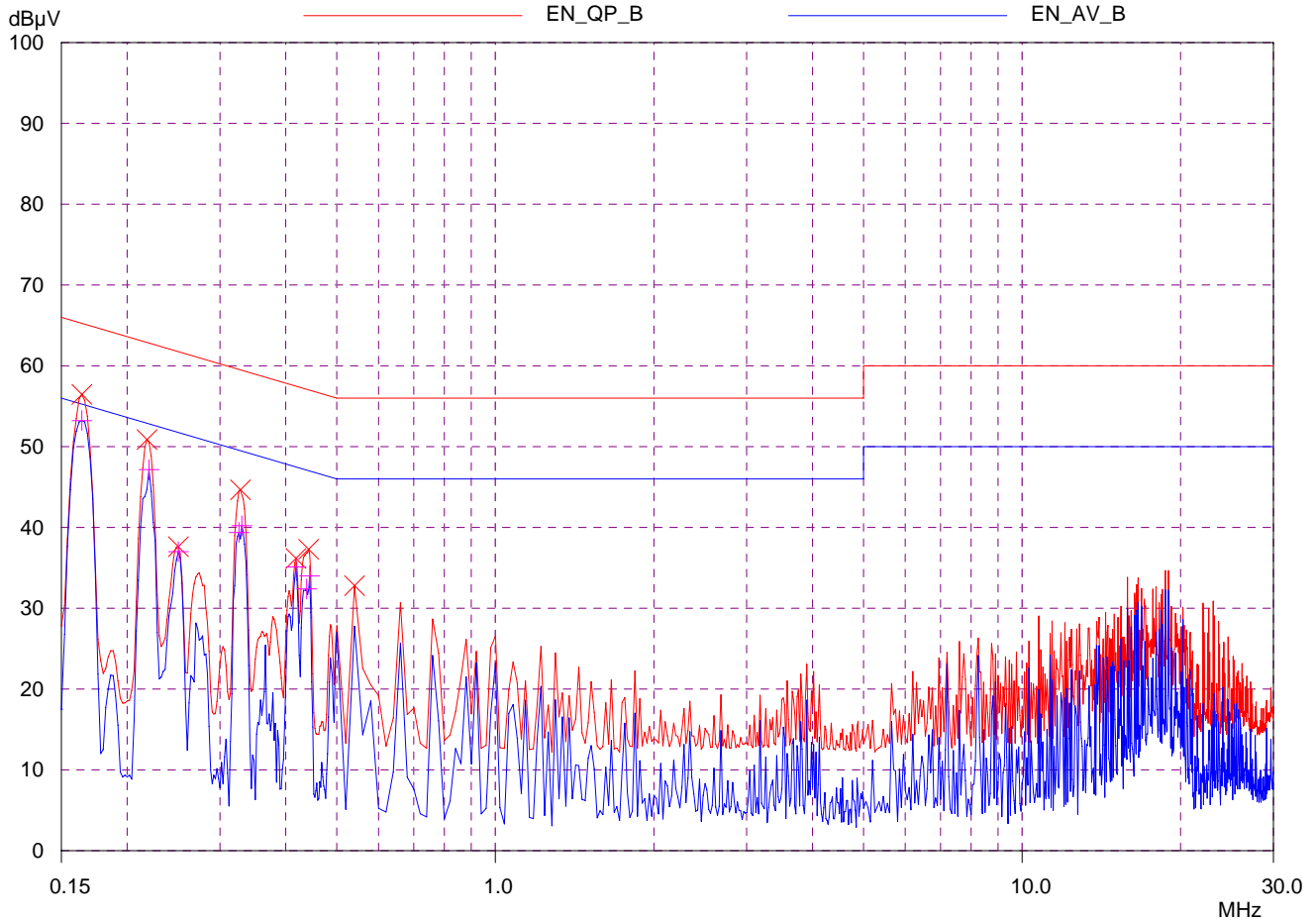

# ZIPPY EMC LAB

## conduction test

EUT: MRW-6400P SPS  
 Manuf: ZIPPY TECH CO..LTD  
 Op Cond: FULL LOAD  
 Operator:  
 Test Spec: EN 55022-- Class B  
 Comment: Load Condition(19 20 0.5 1.2 13 2)  
 L220V

### Scan Settings (3 Ranges)

Frequencies				Receiver Settings				
Start	Stop	Step	IF BW	Detector	M-Time	Atten	Preamp	OpRge
150kHz	500kHz	2kHz	10kHz	QP+AV	1msec	Auto	OFF	60dB
500kHz	5MHz	20kHz	10kHz	QP+AV	1msec	Auto	OFF	60dB
5MHz	30MHz	50kHz	10kHz	QP+AV	1msec	Auto	OFF	60dB

Transducer	No.	Start	Stop	Name
	1	9kHz	30MHz	CEB

Prescan Measurement: Detectors: X QP / + AV  
 Meas Time: see scan settings  
 Peaks: 8  
 Acc Margin: 25 dB

### Peak Search Results

Frequency MHz	QP Level dBµV	QP Limit dBµV	QP Delta dB	Phase	PE
0.164	56.46	65.26	8.80	N	gnd
0.218	50.87	62.89	12.02	N	gnd
0.25	37.62	61.76	24.14	N	gnd
0.328	44.66	59.50	14.84	N	gnd
0.418	36.18	57.49	21.31	N	gnd
0.442	37.31	57.02	19.71	N	gnd
0.54	32.80	56.00	23.20	N	gnd

Frequency MHz	AV Level dBµV	AV Limit dBµV	AV Delta dB	Phase	PE
0.164	53.22	55.26	2.04	N	gnd
0.22	47.15	52.82	5.67	N	gnd
0.25	36.99	51.76	14.77	N	gnd
0.326	39.38	49.55	10.17	N	gnd
0.33	40.21	49.45	9.24	N	gnd
0.418	35.11	47.49	12.38	N	gnd
0.438	32.38	47.10	14.72	N	gnd
0.444	34.01	46.99	12.98	N	gnd

\* limit exceeded

Indicated Phase/PE shows Configuration of max. Emission

# ZIPPY EMC LAB

## conduction test

EUT: MRW-6400P SPS  
 Manuf: ZIPPY TECH CO..LTD  
 Op Cond: FULL LOAD  
 Operator:  
 Test Spec: EN 55022-- Class B  
 Comment: Load Condition(19 20 0.5 1.2 13 2)  
 N220V

Scan Settings (3 Ranges)			Receiver Settings					
Start	Stop	Step	IF BW	Detector	M-Time	Atten	Preamp	OpRge
150kHz	500kHz	2kHz	10kHz	QP+AV	1msec	Auto	OFF	60dB
500kHz	5MHz	20kHz	10kHz	QP+AV	1msec	Auto	OFF	60dB
5MHz	30MHz	50kHz	10kHz	QP+AV	1msec	Auto	OFF	60dB

Transducer	No.	Start	Stop	Name
	1	9kHz	30MHz	CEB

Prescan Measurement: Detectors: X QP / + AV  
 Meas Time: see scan settings  
 Peaks: 8  
 Acc Margin: 25 dB

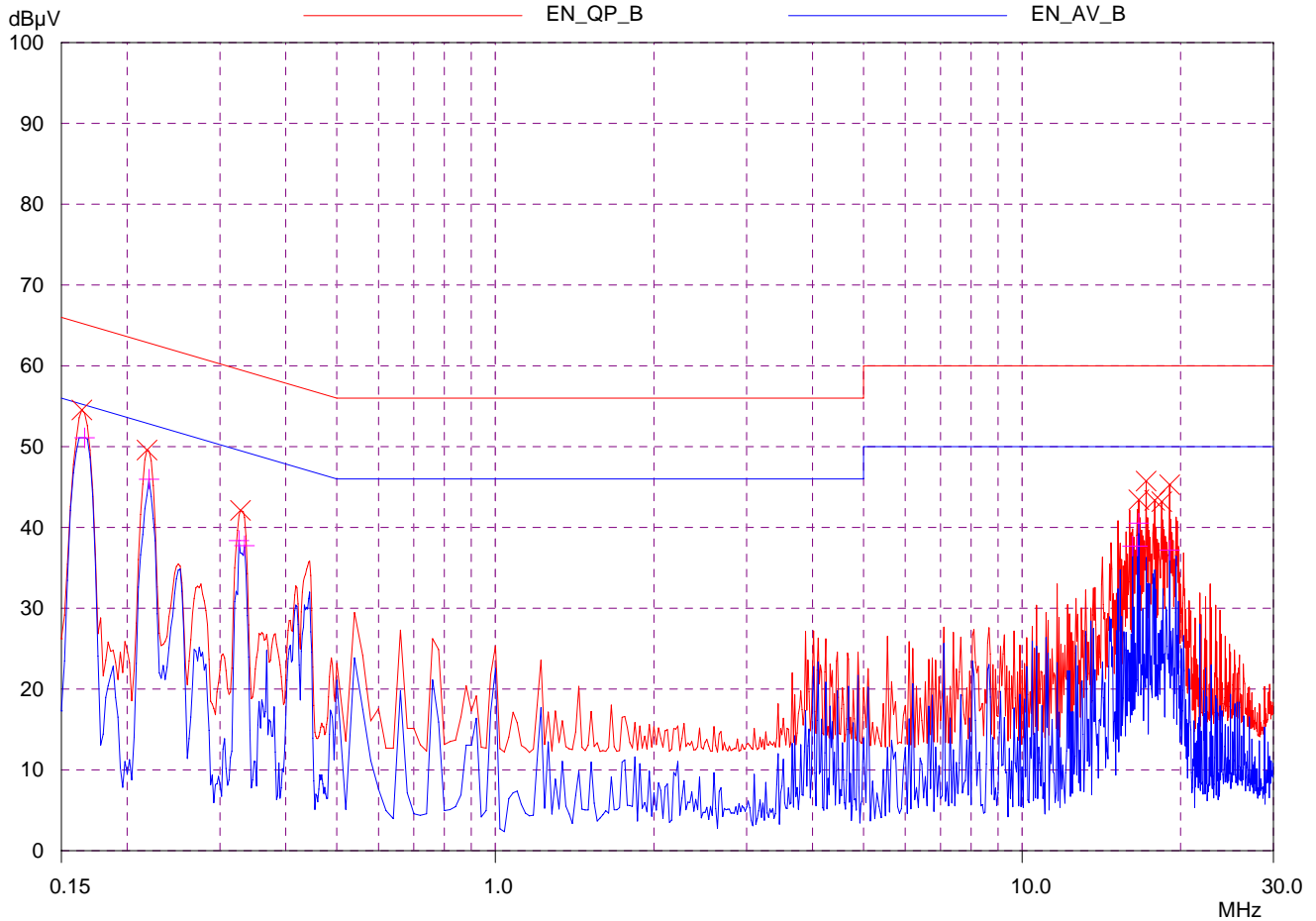

# ZIPPY EMC LAB

## conduction test

EUT: MRW-6400P SPS  
 Manuf: ZIPPY TECH CO..LTD  
 Op Cond: FULL LOAD  
 Operator:  
 Test Spec: EN 55022-- Class B  
 Comment: Load Condition(19 20 0.5 1.2 13 2)  
 N220V

### Scan Settings (3 Ranges)

Frequencies				Receiver Settings				
Start	Stop	Step	IF BW	Detector	M-Time	Atten	Preamp	OpRge
150kHz	500kHz	2kHz	10kHz	QP+AV	1msec	Auto	OFF	60dB
500kHz	5MHz	20kHz	10kHz	QP+AV	1msec	Auto	OFF	60dB
5MHz	30MHz	50kHz	10kHz	QP+AV	1msec	Auto	OFF	60dB

Transducer	No.	Start	Stop	Name
	1	9kHz	30MHz	CEB

Prescan Measurement: Detectors: X QP / + AV  
 Meas Time: see scan settings  
 Peaks: 8  
 Acc Margin: 25 dB

### Peak Search Results

Frequency MHz	QP Level dBµV	QP Limit dBµV	QP Delta dB	Phase -	PE -
0.164	54.54	65.26	10.72	N	gnd
0.218	49.58	62.89	13.31	N	gnd
0.328	42.10	59.50	17.40	N	gnd
16.65	43.43	60.00	16.57	N	gnd
17.2	45.73	60.00	14.27	N	gnd
17.85	43.35	60.00	16.65	N	gnd
18.4	43.19	60.00	16.81	N	gnd
19.05	45.30	60.00	14.70	N	gnd

Frequency MHz	AV Level dBµV	AV Limit dBµV	AV Delta dB	Phase -	PE -
0.166	51.10	55.16	4.06	N	gnd
0.22	45.97	52.82	6.85	N	gnd
0.326	38.38	49.55	11.17	N	gnd
0.334	37.75	49.35	11.60	N	gnd
16.2	37.69	50.00	12.31	N	gnd
16.55	37.69	50.00	12.31	N	gnd
16.65	40.54	50.00	9.46	N	gnd
19.05	37.19	50.00	12.81	N	gnd

\* limit exceeded

Indicated Phase/PE shows Configuration of max. Emission

## 3.2 Radiation Emission Test

### 3.2.1 Test Equipment

The following test equipment's are used during the radiated emission test :

Instrument	Manufacture	Type No:	Last Calibration
Spectrum Analyzer	H.P	8594A	May.,2013
Test Receiver	IFR System	A-7550	Jun.,2013
Preamplifier	H.P	8447D	May.,2013
Biconical Ant.	Emco	3110	Jun.,2013
Log-Periodic Ant.	Emco	3146	Jun.,2013
Dipole Antenna	Emco	3121C	May.,2013

### 3.2.2 Test Setup

#### 3.2.2.1 Block Diagram of Connection between EUT and simulators

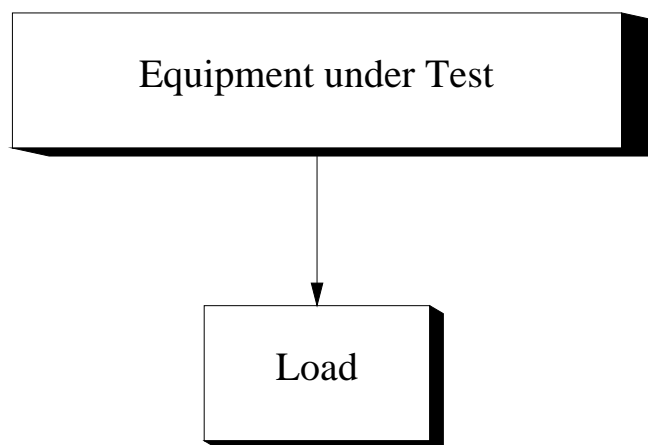

EUT: SWITCHING POWER SUPPLY

3.2.2.2 Open Field Test Site - description

The open field test site (OFTS) is designed to provide an environment in which repeatable tests of radiated emissions can be carried out.

It consists of a flat elliptical area as shown in the diagram below.

The equipment under test and the antenna are placed at the foci of the ellipse.

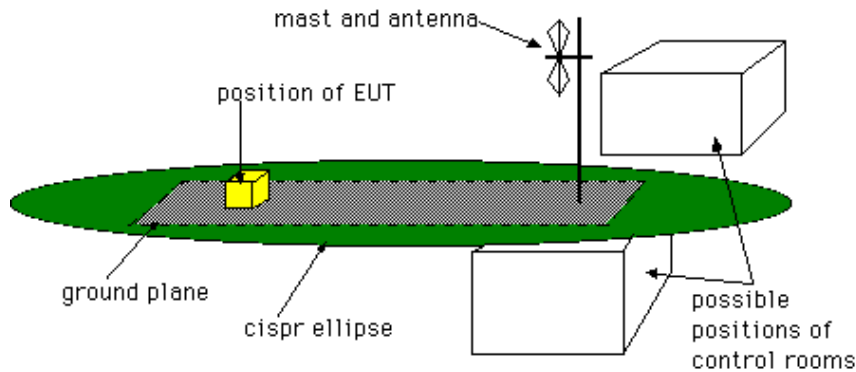

The antenna height should be remotely adjustable from 1m to 4m. Measuring instrumentation should be outside the ellipse at the position shown or in a room under the ground plane.

The whole or part of the site may be enclosed in an RF transparent building.

For precompliance testing a 3m test site with a fixed height antenna (at 1.5-2m height) and no metallic ground plane may be used. This may be a clear area on a car park or a grass area but should be away from large metallic structures.

3.2.3 Radiated Emission Limit

Class B Limits

Frequency	Distance	Field Strength
MHz	Meter	DB(uV/M)
30-230	10	30
230-1000	10	37

Remarks :

1. The tighter limit shall apply at the edge between two frequency bands.
2. Distance refers to the distance in meters between the measuring instrument antenna and the closed point of any part of the device or system.



### 3.2.4 EUT Configuration

The equipment's which is listed 4.2.1 are installed on Radiated Emission Test to meet the Commission requirement and operating in a manner which tends to maximize its emission characteristics in a normal application.

### 3.2.5 Operation Condition of EUT

Same as Conducted Power Line Test which is listed in 3.1.5 .

### 3.2.6 Radiated Emission Data

The measurement range of radiated emission which is from 30 MHz to 1000 MHz was investigated. The initial step in collecting conducted data is a spectrum analyzer peak scan of the measurement range for all the test modes. Then the worst modes were reported the following data pages.

Radiated Emission Data

EUT : SWITCH POWER SUPPLY TEMPERATURE : 26°C

TEST MODE : MRW-6400P HUMIDITY : 57%

Frequency (MHz)	Emission Level	Limits dBuV/m	Remark
	Horizontal dBuV/m		
30.00	13.47	30.00	
144.46	12.14	30.00	
256.98	14.51	37.00	
493.66	20.71	37.00	
623.64	22.46	37.00	
877.78	25.47	37.00	

Radiated Emission Data

EUT : SWITCH POWER SUPPLY TEMPERATURE : 26°C

TEST MODE : MRW-6400P HUMIDITY : 57%

Frequency (MHz)	Emission Level	Limits dBuV/m	Remark
	Vertical dBuV/m		
53.28	14.94	30.00	
90.14	19.60	30.00	
179.38	16.90	30.00	
249.22	20.75	37.00	
650.80	23.39	37.00	
871.96	25.76	37.00	

### Horizontal Curve

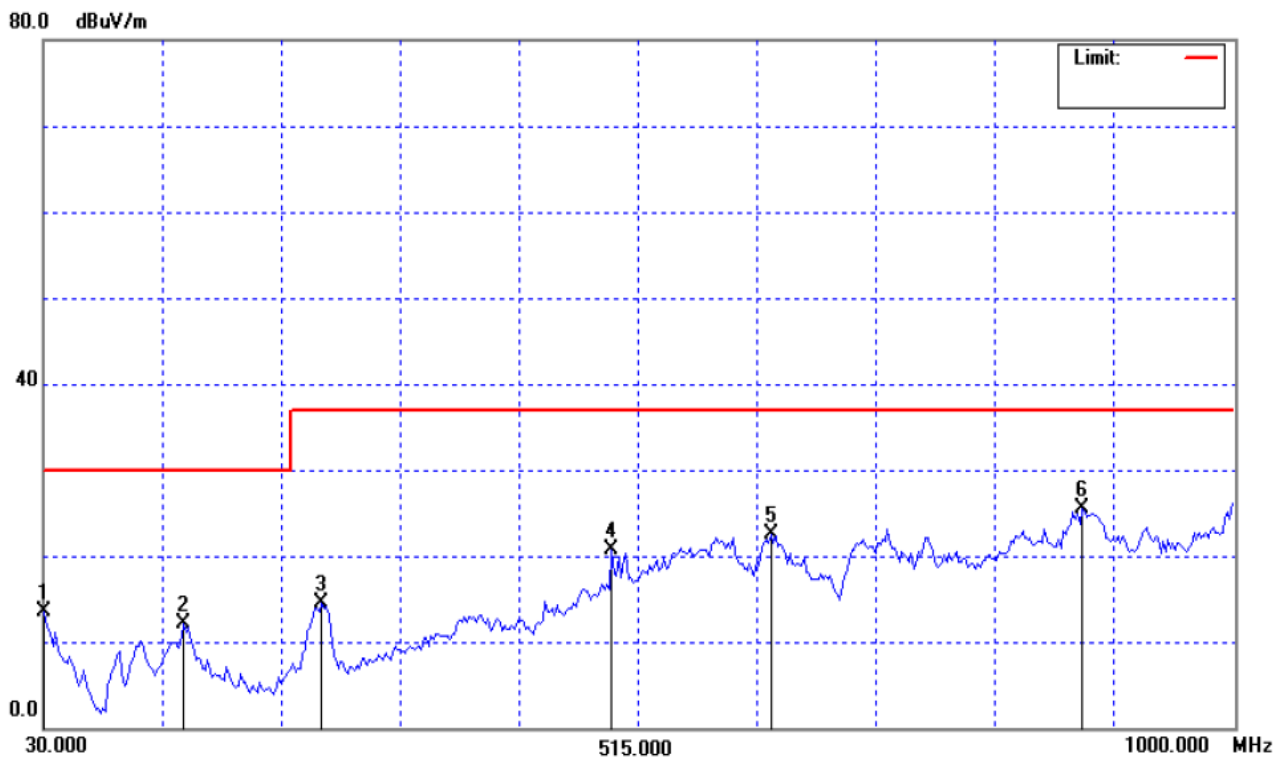

### Vertical Curve

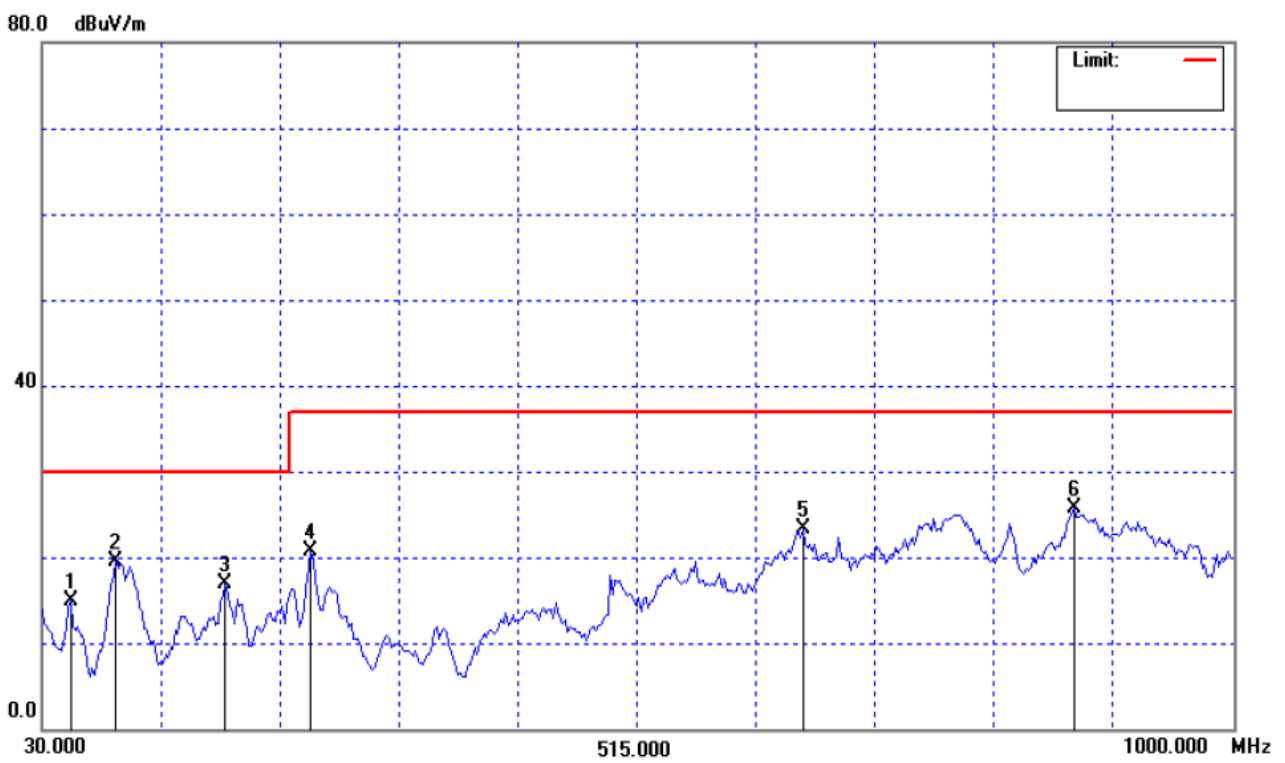

### 3.2.7 Test Photo and Setup

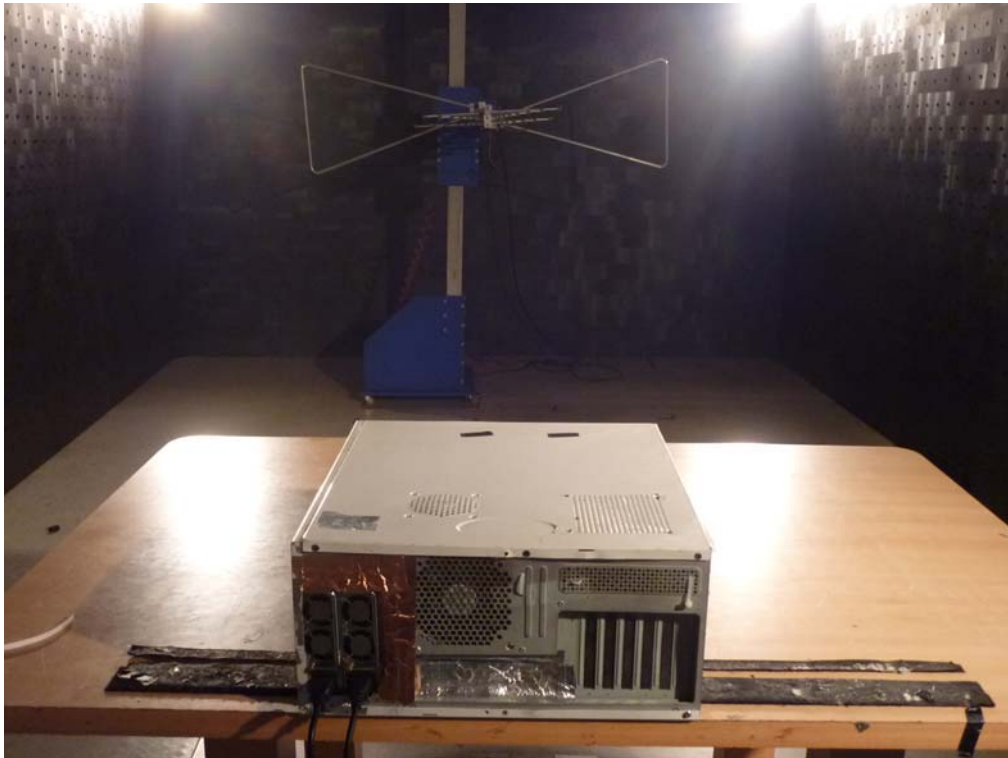

※During the radiated test, the power-supply has to test with chassis, which is not allowed to be operated stand-alone. (For user, final assembly has to comply with corresponding EMC-and safety-regulations.)

## 4. ESD Measurement

### 4.1 Test Equipment

The following test equipment's are used during the ESD test :

Instrument	Manufacture	Type No:	Last Calibration
ESD Simulator system	Keytek	MZ-15/EC	May.,2013
Electronic Load	D-RAM	Load-2000	N/A

### 4.2 Test Setup

#### 4.2.1 Block Diagram of Connections between EUT and simulators

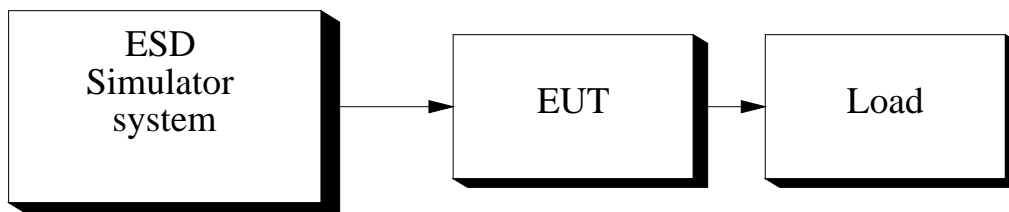

#### 4.2.2 Test Setup of EUT

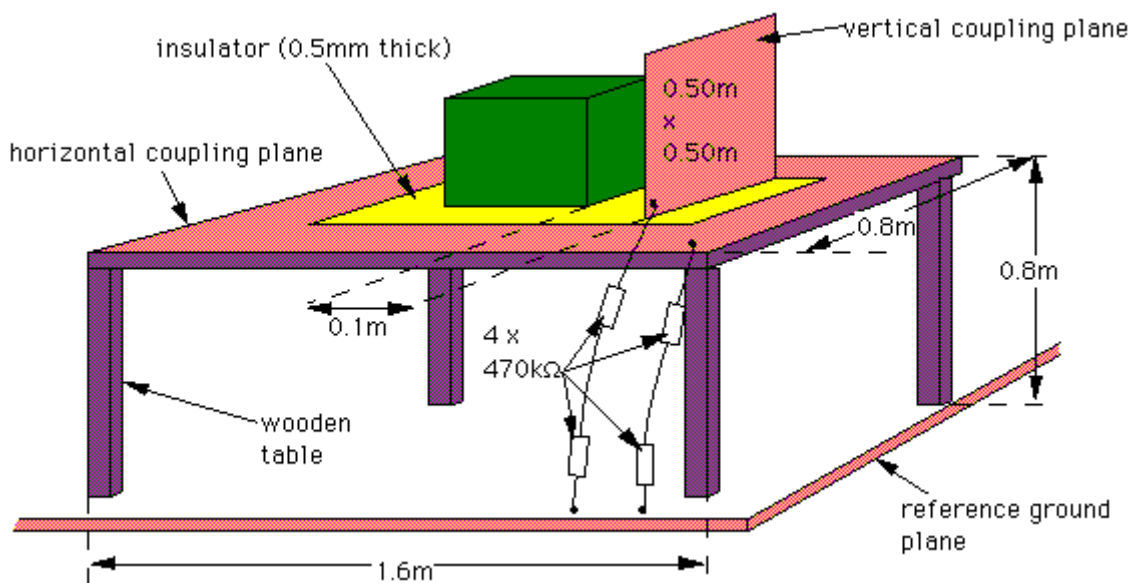

### 4.3 Severity Levels

LEVEL	TEST VOLTAGE CONTACT DISCHARGE	TEST VOLTAGE AIR DISCHARGE
1	2KV	2KV
2	4KV	4KV
3	6KV	6KV
4	8KV	8KV
X	SPECIAL	SPECIAL

### 4.4 EUT Operating Condition

1. Setup the EUT and Test Equipment as shown on 4.2
2. power on.

### 4.5 Test Procedure

Air Discharge:

This test was done above a non-conductive surfaces. The round discharge electrode about 30cm away will approach as fast as possible to touch test points of the EUT.

Discharge happens before the contact. This procedure is repeated ten times on one selected location.

### 4.6 Test Method

According to IEC 61000-4-2

## 4.7 Test Result

EUT : SWITCH POWER SUPPLY TEMPERATURE : 26°CTEST MODE : MRW-6400P HUMIDITY : 65%

Item	Amount of discharge	Voltage	Results
Contact discharge	500	+2KV -2KV	Pass Pass
Contact discharge	500	+4KV -4KV	Pass Pass
Air discharge	500	+2KV -2KV	Pass Pass
Air discharge	500	+4KV -4KV	Pass Pass
Air discharge	500	+6KV -6KV	Pass Pass
Air discharge	500	+8KV -8KV	Pass Pass

※Input Voltage / Frequency : 230Vac/50Hz



## 5. Radiated Susceptibility Measurement

### 5.1 Test Equipment

The following test equipment's are used during the RS test :

Instrument	Manufacture	Type No:	Last Calibration
Signal generator	H.P	8657A	Dec.,2012
Power amplifier	A&R	100A100	Dec.,2012
Field strength meter	A&R	FM2000	Oct.,2013
Field strength sensor	A&R	EP2000	Oct.,2013
Power antenna	A&R	AT1080	Oct.,2013

### 5.2 Block Diagram of Test Setup

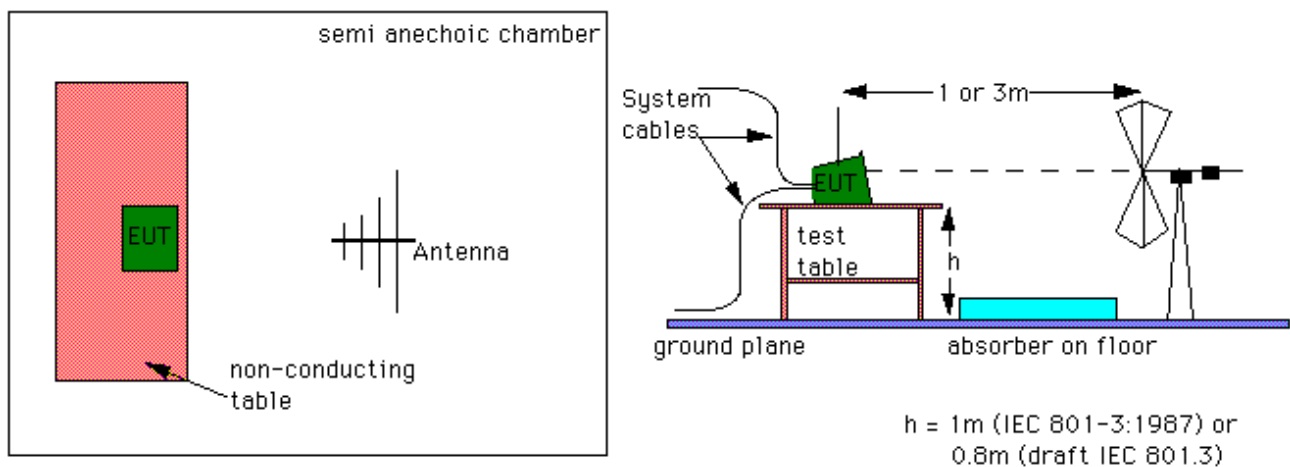

Antennas-layout

For the upper frequency range of 200 to 1000 MHz, antennas are the normal method of producing the required field strength. This is also carried out in an anechoic chamber or a screened room. If a screened room is used it must be damped. The anechoic chamber should be used for compliance testing, the screened room may be used for precompliance testing. The fields in the screened room will not be as uniform as those obtainable in an anechoic chamber and will also not be as repeatable. The EUT is placed on a non-conductive table, 0.8 m above the reference ground plane, which in many cases will be the floor of a screened room. According to the standards, the EUT should be oriented so that its most sensitive side is facing the antenna. In practice it can be difficult to decide beforehand which is the most sensitive side, and in most cases, a series of tests will be required with the EUT in several orientations.

### 5.3 Severity Levels

LEVEL	FIELD STRENGTH V/M
1	1
2	3
3	10
X	SPECIAL

### 5.4 EUT Operating Condition

Same as section 4.4.

### 5.5 Test Procedure

The EUT and load are placed on a table which is 0.8 meter above ground. The field sensor is also placed on the same table to monitor field strength from transmitting antenna.

EUT is set 1 meter away from the transmitting antenna which is mounted on an antenna each time.

The antenna is fixed 1 meter above ground. Both horizontal and vertical polarization of the antenna are set on measurement. In order to judge the EUT performance, a CCD camera is used to monitor EUT screen.

All the scanning conditions are as follows :

Condition of Test	Remarks
1. Field Strength	3 V/M Level 2
2. Radiated Signal	80% Amplitude Modulated with a 1KHz Tone
3. Scanning Frequency	80 MHz-1 GHz
4. Sweep Time of Radiated	0.0015 Decade/s

### 5.6 Test Method

According to IEC 61000-4-3

## 5.7 Test Result

EUT : SWITCH POWER SUPPLY TEMPERATURE : 26°CTEST MODE : MRW-6400P HUMIDITY : 65%

Frequency Range (MHz)	Position (Angle)	Polarity (HorV)	Field Strength (V/M)	Results
80-1000	0° (Front)	H	3	Pass
80-1000	90° (Right)	H	3	Pass
80-1000	180° (Back)	H	3	Pass
80-1000	270° (Left)	H	3	Pass
80-1000	0° (Front)	V	3	Pass
80-1000	90° (Right)	V	3	Pass
80-1000	180° (Back)	V	3	Pass
80-1000	270° (Left)	V	3	Pass

Test Result : Criteria A

## 6. Electrical Fast Transient / Burst Measurement

### 6.1 Test Equipment

The following test equipment's are used during the EFT tests :

Instrument	Manufacturer	Type No.	Last Calibration
Fast Transient / Burst enerator	Keytek	EMCpro	May.,2013

### 6.2 Block Diagram of Test Setup

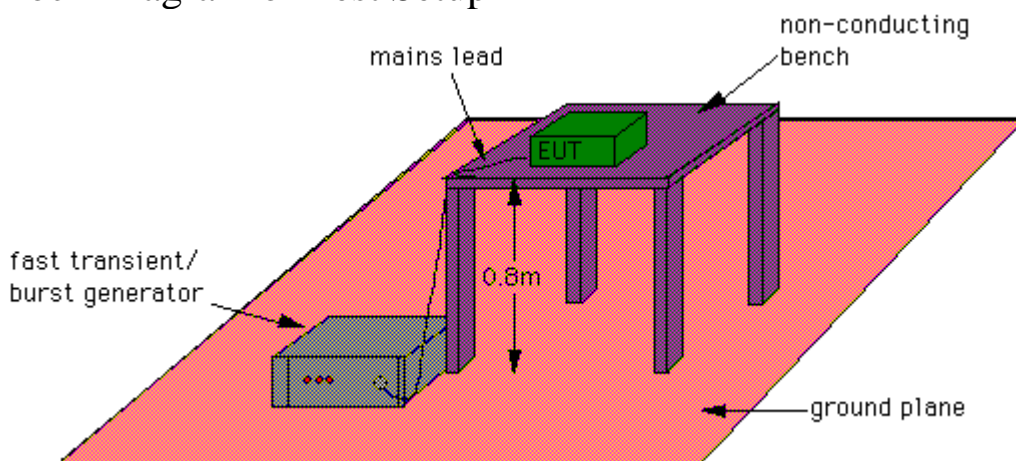

### 6.3 Severity Levels

Open Circuit Output Test Voltage +/- 10%	
Level	On power supply lines
1	0.5KV
2	1KV
3	2KV
4	4KV
X	SPECIAL

## 6.4 EUT Operation Condition

Same as section 4.4.

## 6.5 Test Procedure

The EUT and its load are placed on a table which is 0.8 meter above a metal ground plane measured 1m\*1m min. And 0.65 mm thick min. And projected beyond the EUT by at least 0.1m on all sides.

The EUT is away from the walls of the test AC power line test is as follows:

For Ac power line test:

The EUT is connected to the power mains through a coupling device that directly couples the EFT interference signal.

Each of the Line and Neutral conductor is impressed with burst noise for 1 min.

## 6.6 Test Method

According to IEC 61000-4-4.

## 6.7 Test Result

EUT : SWITCH POWER SUPPLY TEMPERATURE : 26°C

TEST MODE : MRW-6400P HUMIDITY : 65%

Inject Line	Voltage KV	Inject time (sec)	Inject Method	Result
L1	+/-1	60	Direct	Pass
L2	+/-1	60	Direct	Pass
PE	+/-1	60	Direct	Pass
L1-L2	+/-1	60	Direct	Pass
L1-PE	+/-1	60	Direct	Pass
L2-PE	+/-1	60	Direct	Pass
L1,L2-PE	+/-1	60	Direct	Pass

※Input Voltage / Frequency : 230Vac/50Hz

## 7. Harmonic Current Test

EUT : SWITCH POWER SUPPLY      TEMPERATURE : 26°C

TEST MODE : MRW-6400P      HUMIDITY : 65%

Item	Reading Leve A		Item	Reading Leve A	
	A	Limites		A	Limites
1	2.424				
3	0.354	1.876			
5	0.049	1.049			
7	0.034	0.552			
9	0.023	0.276			
11	0.013	0.193			
13	0.011	0.163			
15	0.011	0.142			
17	0.008	0.125			
19	0.014	0.112			
21	0.012	0.101			
23	0.012	0.092			
25	0.007	0.085			
27	0.009	0.079			
29	0.008	0.073			
31	0.007	0.069			
33	0.006	0.064			
35	0.002	0.061			
37	0.002	0.057			
39	0.001	0.054			



ANALYZER 6630

### Current Harmonics

Setup: CLASS\_D    Gen setting: 1(1)    U : 230.13 V    fu: 50.001 Hz  
 Live            Analysed periods: 4    I : 2.450 A    P: 0.552 kW  
 Module: M1      Limit: Class D (User def)    I1: 2.424 A  
 Note:  
 THD=14.91 % (PF=0.979)    PASSED

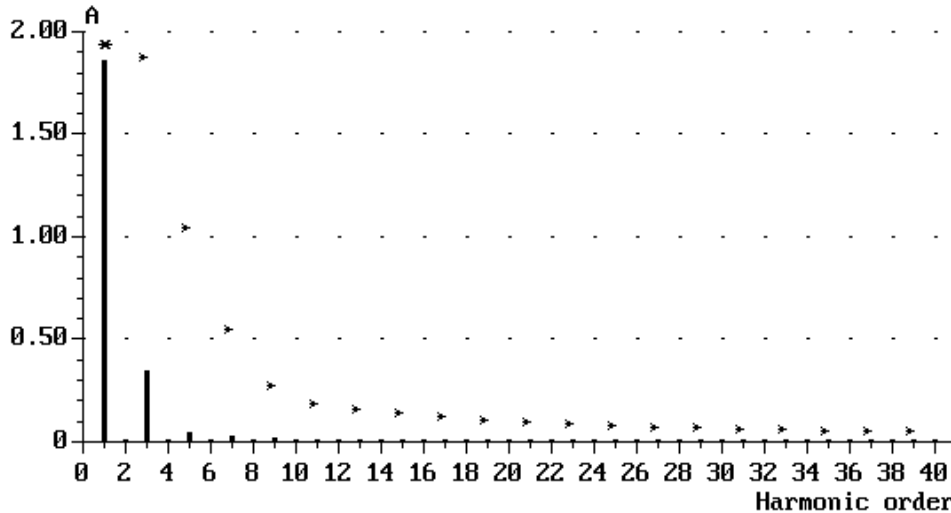

Appl: EUROPE

Next measure

---

Change to table

---

Relative current

---

Log scale

---

Write to disk

---



(1212\_00)



ANALYZER 6630

### Current Harmonics

Setup: CLASS\_D    Gen setting: 1(1)    U : 230.13 V    fu: 50.001 Hz  
 Live            Analysed periods: 4    I : 2.450 A    P: 0.552 kW  
 Module: M1      Limit: Class D (User def)    I1: 2.424 A  
 Note:  
 THD=14.91 % (PF=0.979)    PASSED

No	A	Lim A	No	A	Lim A	No	A	Lim A
1	2.424		15	0.011	0.142	29	0.008	0.073
2	0.008		16	0.000		30	0.000	
3	0.354	1.876	17	0.008	0.125	31	0.007	0.069
4	0.001		18	0.000		32	0.000	
5	0.049	1.049	19	0.014	0.112	33	0.006	0.064
6	0.001		20	0.000		34	0.000	
7	0.034	0.552	21	0.012	0.101	35	0.002	0.061
8	0.001		22	0.000		36	0.000	
9	0.023	0.276	23	0.012	0.092	37	0.002	0.057
10	0.001		24	0.001		38	0.001	
11	0.013	0.193	25	0.007	0.085	39	0.001	0.054
12	0.000		26	0.001		40	0.001	
13	0.011	0.163	27	0.009	0.079			
14	0.000		28	0.000				

Current range: 10 Ap

Appl: EUROPE

Next measure

---

Change to bar graph

---

Relative current

---

Write to disk

---



(1212\_01)



### 8. Voltage Fluctuation And Flicker Test

EUT : SWITCH POWER SUPPLY TEMPERATURE : 26°C

TEST MODE : MRW-6400P HUMIDITY : 65%

Item	Reading	Limit	Result
Pst	0.000	1.00	Pass
P1t	0.000	0.65	Pass
Dc (%)	0.000	3.00	Pass
Dmax (%)	0.000	4.00	Pass
Dt (%)	0.000	0.20	Pass

## 9. Surge Immunity Test

EUT : SWITCH POWER SUPPLY TEMPERATURE : 26°C

TEST MODE : MRW-6400P HUMIDITY : 65%

Waveform	Voltage	Output:LC	Phs Ref	Phs Ang	Tests	Delay	Result
12 Ohm	-2000V	MAINS:L1/PE	L1	0 deg.	5	60 sec	Pass
12 Ohm	-2000V	MAINS:L1/PE	L1	90 deg.	5	60 sec	Pass
12 Ohm	-2000V	MAINS:L1/PE	L1	270 deg.	5	60 sec	Pass
12 Ohm	2000V	MAINS:L1/PE	L1	0 deg.	5	60 sec	Pass
12 Ohm	2000V	MAINS:L1/PE	L1	90 deg.	5	60 sec	Pass
12 Ohm	2000V	MAINS:L1/PE	L1	270 deg.	5	60 sec	Pass
12 Ohm	-2000V	MAINS:L2/PE	L1	0 deg.	5	60 sec	Pass
12 Ohm	-2000V	MAINS:L2/PE	L1	90 deg.	5	60 sec	Pass
12 Ohm	-2000V	MAINS:L2/PE	L1	270 deg.	5	60 sec	Pass
12 Ohm	2000V	MAINS:L2/PE	L1	0 deg.	5	60 sec	Pass
12 Ohm	2000V	MAINS:L2/PE	L1	90 deg.	5	60 sec	Pass
12 Ohm	2000V	MAINS:L2/PE	L1	270 deg.	5	60 sec	Pass
2 Ohm	-1000V	MAINS:L1/L2	L1	0 deg.	5	60 sec	Pass
2 Ohm	-1000V	MAINS:L1/L2	L1	90 deg.	5	60 sec	Pass
2 Ohm	-1000V	MAINS:L1/L2	L1	270 deg.	5	60 sec	Pass
2 Ohm	1000V	MAINS:L1/L2	L1	0 deg.	5	60 sec	Pass
2 Ohm	1000V	MAINS:L1/L2	L1	90 deg.	5	60 sec	Pass
2 Ohm	1000V	MAINS:L1/L2	L1	270 deg.	5	60 sec	Pass

## 10. Conducted Immunity Test

EUT : SWITCH POWER SUPPLY TEMPERATURE : 26°C

TEST MODE : MRW-6400P HUMIDITY : 65%

Test frequency Range : 150kHz ~ 80MHz

Frequency Step : 1% of the momentary frequency

Dwell Time : Minimum 3 sec. per frequency

Modulation : 1kHz Sine Wave with 80% Amplitude Modulation

Frequency Range (MHz)	Polarity (HorV)	Field Strength (V/M)	Performance		Result
			Required	Observation	
0.15-80	H	3	A	A	Pass

## 11. Voltage Dip, Interruptions Immunity Test

EUT : SWITCH POWER SUPPLY TEMPERATURE : 26°C

TEST MODE : MRW-6400P HUMIDITY : 65%

Test Voltage	Phase Angle	Reduction %	Duration (Periods)	Performance		Result
				Required	Observation	
AC 115V	0 deg.	>95%	0.5	B	A	Pass
	90 deg.		0.5	B	A	Pass
	180 deg.		0.5	B	A	Pass
	270 deg.		0.5	B	A	Pass
	0 deg.	30%	25	C	A	Pass
	90 deg.		25	C	A	Pass
	180 deg.		25	C	A	Pass
	270 deg.		25	C	A	Pass
	0 deg.	>95%	250	C	C	Pass
	90 deg.		250	C	C	Pass
	180 deg.		250	C	C	Pass
	270 deg.		250	C	C	Pass
AC 230V	0 deg.	>95%	0.5	B	A	Pass
	90 deg.		0.5	B	A	Pass
	180 deg.		0.5	B	A	Pass
	270 deg.		0.5	B	A	Pass
	0 deg.	30%	25	C	A	Pass
	90 deg.		25	C	A	Pass
	180 deg.		25	C	A	Pass
	270 deg.		25	C	A	Pass
	0 deg.	>95%	250	C	C	Pass
	90 deg.		250	C	C	Pass
	180 deg.		250	C	C	Pass
	270 deg.		250	C	C	Pass

## 12. Power Frequency Magnetic Field (PFM) Immunity Test

EUT : SWITCH POWER SUPPLY TEMPERATURE : 26°C

TEST MODE : MRW-6400P HUMIDITY : 65%

Magnetic Field Orientation	Magnetic Field (A/m)	Performance		Result (Pass/Fail)
		Required	Observation	
X-axis	1A	A	A	Pass
Y-axis	1A	A	A	Pass
Z-axis	1A	A	A	Pass

### 13. Photographs

- 1.Front view of Power Supply
- 2.Back view of Power Supply



3.Front view of Power Supply

4.Back view of Power Supply



5.Component side of Mainboard

6.Solder side of Mainboard

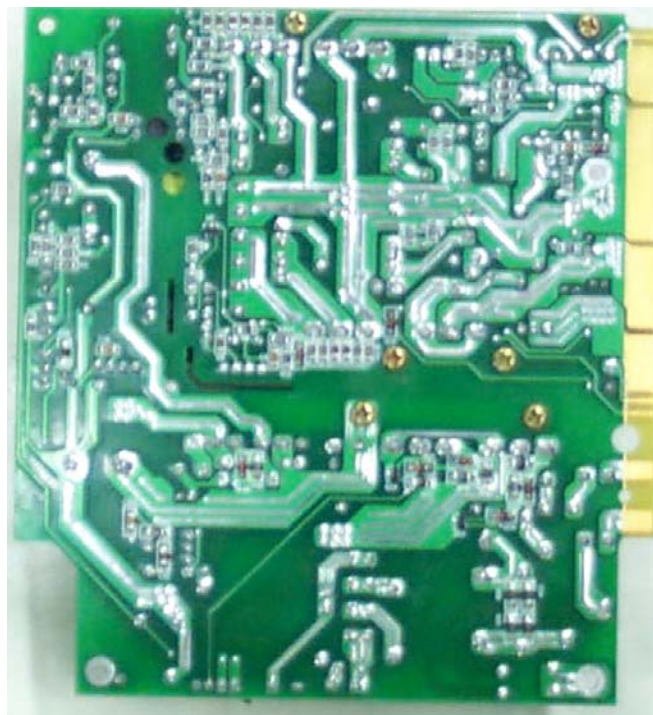
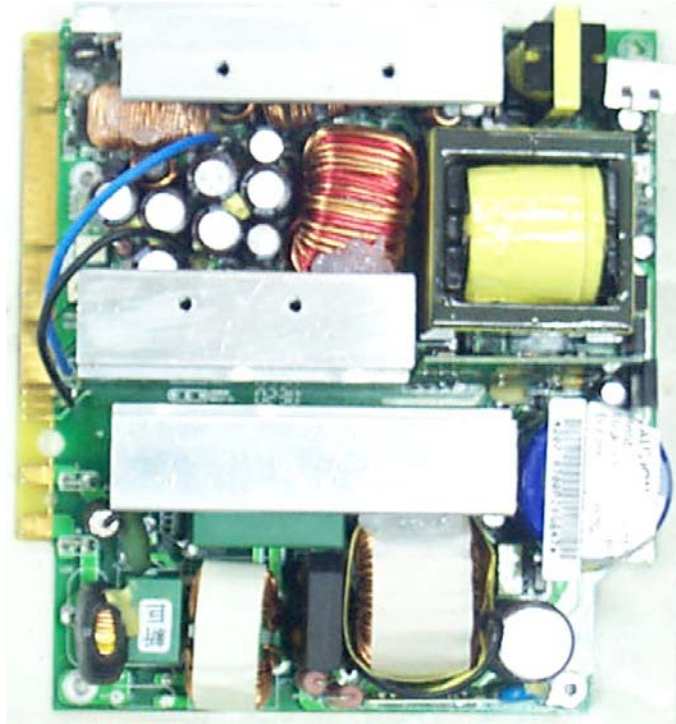



7.Component side of Mainboard

8.Solder side of Mainboard

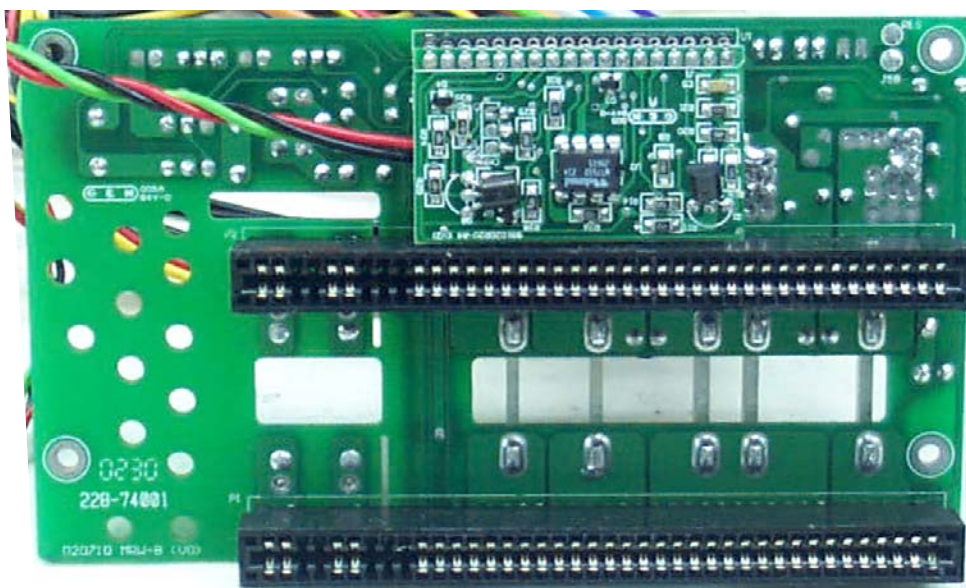
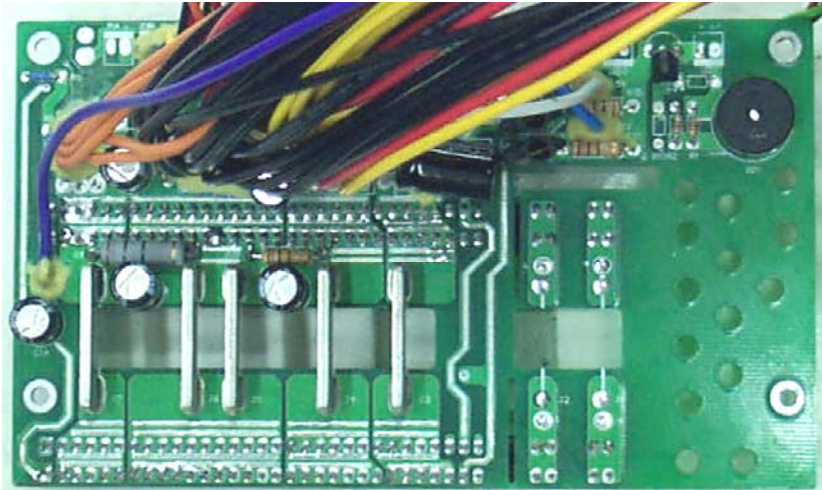

- 9. Inside view of Power Supply
- 10. Inside view of Power Supply

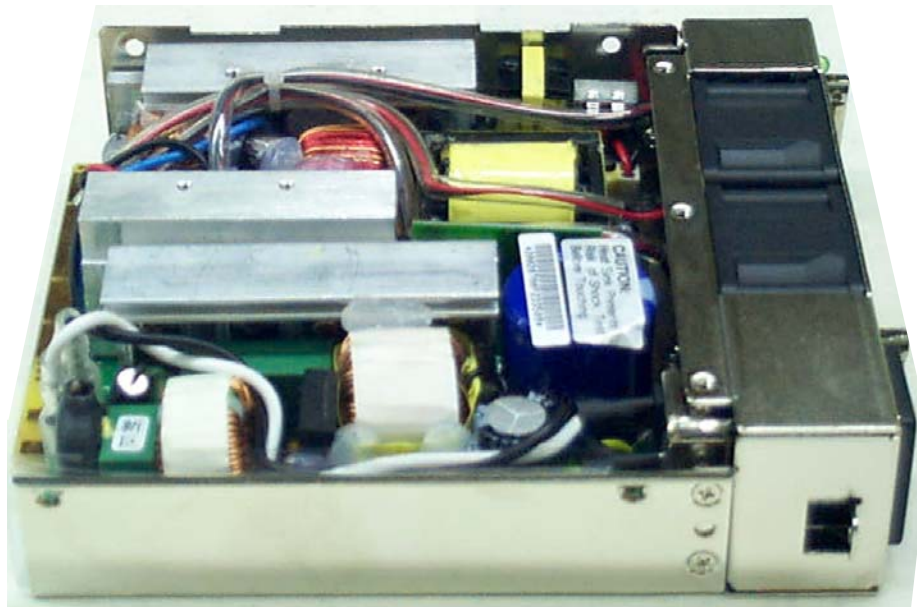
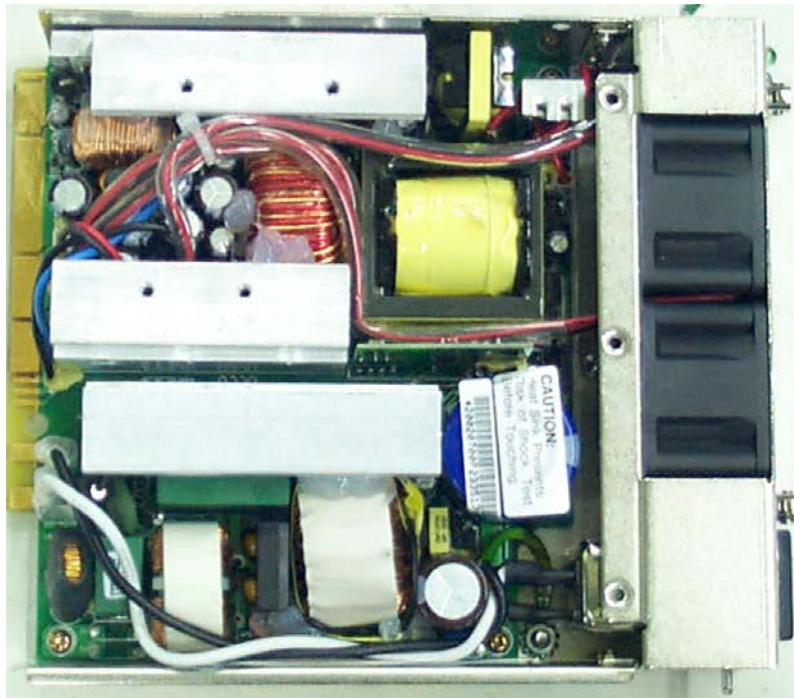

11. Inside view of Power Supply

12. Test view

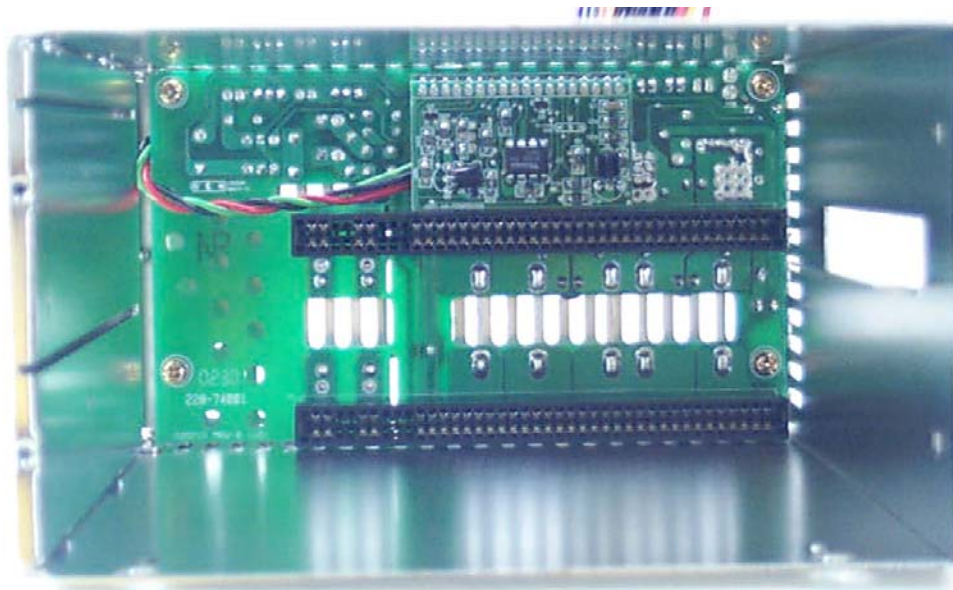

## **14. EMI Reduction Method During Compliance Testing**

1.No modification was made during test.