

# Declaration of Conformity

## We, Manufacturer

ZIPPY TECHNOLOGY CORP.  
10F, No.50, MIN MINQUAN RD.  
XINDIAN DIST, NEW TAIPEI CITY  
TAIWAN, R.O.C.

declare that the product  
(description of the apparatus, system, installation to which it refers)

### SWITCHING POWER SUPPLY

#### **R1S2-5300V4H**

is in conformity with  
(reference to the specification under which conformity is declared)  
in accordance with 2014/30/EU-EMC Directive

- |   |   |
|---|---|
| ■ EN 55022 : 2010<br>Information technology equipment<br>-Radio disturbance characteristics<br>-Limits and methods of measurement | ■ EN 61000-4-5 : 2014 Criteria B<br>Surge Immunity requirements   |
| ■ EN 55024 : 2010<br>Information technology equipment<br>-Immunity characteristics<br>-Limits and methods of measurement          | ■ EN 61000-4-6 : 2014 Criteria A<br>Conducted Immunity  |
| ■ EN 61000-4-2 : 2009 Criteria B<br>Electrostatic discharge requirements "ESD"  | ■ EN 61000-4-8 : 2010 Criteria A<br>Power Frequency Magnetic Field Immunity   |
| ■ EN 61000-4-3 : 2006+A1:2008+A2:2010<br>Criteria A<br>Radiated, radio frequency electromagnetic field                            | ■ EN 61000-4-11 : 2004<br>Dip Criteria B<br>Interruptions Criteria C<br>Voltage Dip, interruptions<br>Immunity requirements |
| ■ EN 61000-4-4 : 2012 Criteria B<br>Electrical fast transient requirements "EFT"  | ■ EN 61000-3-2 : 2014<br>Harmonic current requirements  |
|   | ■ EN 61000-3-3 : 2013<br>Voltage fluctuations and flicker requirements  |

Checked by : Karen  
(Karen Ma / Engineer)

, Date : APR,26,2016

Approved by : Jeff Huang  
(Jeff Huang / Director)

, Date : APR,26,201

APPLICATION FOR CERTIFICATION  
ON Behalf Of  
ZIPPY TECHNOLOGY CORP.  
SWITCHING POWER SUPPLY

Model# : **R1S2-5300V4H**

PREPARED FOR :

ZIPPY TECHNOLOGY CORP.  
10F., No.50, MINQUAN RD.,  
XINDIAN DIST., NEW TAIPEI CITY  
TAIWAN, R.O.C

REPORT BY :

ZIPPY TECHNOLOGY CORP.  
10F., No.50, MINQUAN RD.,  
XINDIAN DIST., NEW TAIPEI CITY  
TAIWAN, R.O.C  
TEL : (02)2918-8512  
FAX : (02)2913-4969

## TABLE OF CONTENTS

Description	Page
<b>1. Test Report Certification</b> .....	5
<b>2. General Information</b> .....	6
2.1 Production Description.....	6
2.2 Tested System Details.....	7
2.2.1 Resistor Load.....	7
2.3 Test Methodology.....	7
2.4 Test Facility.....	7
<b>3. Electronic-Magnetic Interference Test</b> .....	8
3.1. Conducted Power Line Test.....	8
3.1.1 Test Equipments.....	8
3.1.2 Block Diagram of Test Setup.....	8
3.1.3 Conducted Powerline Emission Limit.....	9
3.1.4 EUT Configuration on Measurement.....	9
3.1.5 EUT Exercise Software.....	9
3.1.6 Conducted Emission Data.....	9
3.2. Radiation Emission Test .....	15
3.2.1 Test Equipment .....	15
3.2.2 Test Setup .....	15
3.2.3 Radiated Emission Limited .....	16
3.2.4 EUT Configuration .....	17
3.2.5 Operating Condition of EUT .....	17
3.2.6 Radiated Emission Data .....	17
3.2.7 Test Photo and Setup .....	21
<b>4. ESD Measurement</b> .....	22
4.1 Test Equipments.....	22
4.2 Test Setup.....	22
4.2.1 Block Diagram of Connections between EUT and simulators.....	22
4.2.2 Test Setup of EUT.....	22
4.3 Severity Levels.....	23
4.4 EUT Operating Condition.....	23
4.5 Test Procedure.....	23
4.6 Test Method.....	23
4.7 Test Result.....	24

## TABLE OF CONTENTS

Description	Page
<b>5. Radiated Susceptibility Measurement</b> .....	25
5.1 Test Equipment.....	25
5.2 Block Diagram of Test Setup.....	25
5.3 Severity Levels.....	26
5.4 EUT Operating Condition.....	26
5.5 Test procedure.....	26
5.6 Test Method.....	26
5.7 Test Result.....	27
<b>6. Electrical Fast Transient/Burst Measurement</b> .....	28
6.1 Test Equipment .....	28
6.2 Block Diagram of Test Setup.....	28
6.3 Severity Levels .....	28
6.4 EUT Operating Condition.....	29
6.5 Test procedure .....	29
6.6 Test Method.....	29
6.7 Test Result.....	30
<b>7. Harmonic Current Requirements</b> .....	31
<b>8. Voltage Fluctuation and Filcker Test</b> .....	33
<b>9. Surge Immunity Test</b> .....	34
<b>10. Conducted Immunity Test</b> .....	35
<b>11. Voltage Dip,interruptions Immunity Test</b> .....	36
<b>12. Power Frequency Magnetic Field (PFM) Immunity Test</b> .....	37
<b>13. Photographs</b> .....	38
<b>14. EMI Reduction method during compliance Testing</b> .....	44
Appendix A Circuit diagram, block diagram, User Manual	
Appendix B Doc	

## 1. Test Report Certification

Applicant : ZIPPY TECHNOLOGY CORP.

Manufacturer : ZIPPY TECHNOLOGY CORP.

EUT Description : Switching Power Supply

(A) Model No. : R1S2-5300V4H

(B) Serial No. : N/A

(C) Power Supply : 115Vac/60Hz,230Vac/50Hz

MEASUREMENT PROCEDURE USED :

EN 55024 RULES

EN 55022 RULES

THE DEVICE DESCRIBED ABOVE WAS TESTED BY ZIPPY SHIN JIUH CORP. TO DETERMINE THE SEVERITY LEVELS THE DEVICE CAN ENDURE AND ITS PERFORMANCE CRITERION.

THE MEASUREMENT RESULTS ARE CONTAINED IN THIS TEST REPORT AND ZIPPY SHIN JIUH CORP. IS ASSUMED FULL RESPONSIBILITY FOR THE ACCURACY AND COMPLETENESS OF THESE MEASUREMENT.

ALSO, THIS REPORT SHOWS THAT THE EUT TO BE TECHNICALLY COMPLIANT WITH THE EN STANDARD.

## 2. General Information

### 2.1 Production Description

Description : Switching Power Supply

Model Number : **R1S2-5300V4H**

Applicant : ZIPPY TECHNOLOGY CORP.

Address : 10F., No.50, MINQUAN RD.,XINDIAN DIST.,  
NEW TAIPEI CITY TAIWAN, R.O.C

Data Cable : N/A

PowerCord : Non-Shielded, detachable, 1.5m

## 2.2 Tested System Details

The FCC IDs for all equipment, plus descriptions of all cables used in the tested system (including inserted cards, which have grants) are:

### 2.2.1 Resistor Load

Model Number : ELECTRONIC LOAD

Serial Number : N/A

Manufacturer : ZIPPY

Power : 300W

## 2.3 Test Methodology

EMI Test:

Both conducted and radiated testing were performed according to the procedures in EN 55022  
Radiated testing was performed at an antenna to EUT distance of 10 meters.

EMS Test:

Performed according to procedures in EN 61000 series regulations.

## 2.4 Test Facility

ZIPPY TECHNOLOGY CORP.  
10F., No.50, MINQUAN RD.,  
XINDIAN DIST., NEW TAIPEI CITY  
TAIWAN, R.O.C

### 3. Electronic-Magnetic Interference Test

#### 3.1 Conducted Power Line Test

##### 3.1.1 TEST Equipment's

The following test equipment's are used during the conducted power line tests:

Item	Instrument	Manufacture	Type No:	Last Calibration
1	TEST RECEIVER	ROHDE & SCHWARZ	ESL	Mar.,2016
2	LISN	ROHDE & SCHWARZ	ENV4200	Dec.,2015
		ROHDE & SCHWARZ	ENV216	Apr.,2016
3	SHIELDED ROOM 4.0M*3.0M*3M			N/A

##### 3.1.2 Block Diagram of Test Setup

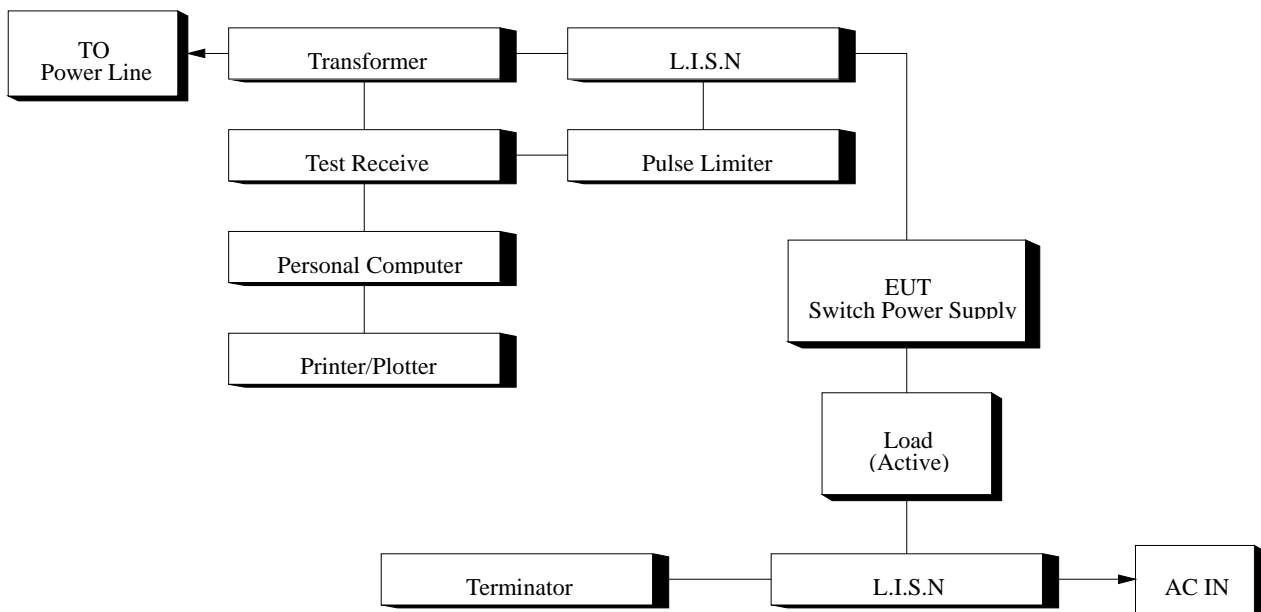



### 3.1.3 Conducted Powerline Emission Limit

Maximum RF Line Voltage dB(uV)		
Frequency	Class A	
MHz	QUASI-PEAK	AVERAGE
0.15 - 0.50	79	66
0.50 - 5.0	73	60
5.0 - 30	73	60

Remarks : In the Above Table, the tighter limit applies at the band edges.

### 3.1.4 EUT Configuration on Measurement

The equipment's which is listed 3.2 are installed on Conducted Power Line Test to meet the Commission requirement and operating in a manner which tends to maximize its emission characteristics in a normal application.

### 3.1.5 EUT Exercise Software

The EUT exercise program used during conducted testing was designed to exercise the EUT in a manner similar to a typical use. The exercise sequence is listed as below :

3.1.5.1 Setup the EUT and simulators as shown on 3.2.

3.1.5.2 Turn on the power of all equipment's.

### 3.1.6 Conducted Emission Data

The measurement range of conducted emission which is from 0.15 MHz to 30 MHz was investigated. The initial step in collecting conducted data is a spectrum analyzer peak scan of the measurement range for all the test modes. Then the worst modes were reported the following data pages.

Conducted Emission Data

EUT : SWITCH POWER SUPPLY      TEMPERATURE : 26°C

TEST MODE : R1S2-5300V4H      HUMIDITY : 65%

Frequency MHz	Reading Level dBuV		Limites
	Line 1	Line 2	DBuV
0.206	58.04	58.08	79.00

Remark : All readings are Quasi-Peak values.

# ZIPPY EMC LAB

## conduction test

EUT: R1S2-5300V4H SPS  
 Manuf: ZIPPY TECH CO..LTD  
 Op Cond: FULL LOAD  
 Operator:  
 Test Spec: EN 55022-- Class A  
 Comment: Load Condition (16 11 0.5 11 2.5)  
 L220V

Scan Settings (3 Ranges)			Receiver Settings					
Start	Stop	Step	IF BW	Detector	M-Time	Atten	Preamp	OpRge
150kHz	500kHz	2kHz	10kHz	QP+AV	50msec	Auto	OFF	60dB
500kHz	5MHz	20kHz	10kHz	QP+AV	1msec	Auto	OFF	60dB
5MHz	30MHz	50kHz	10kHz	QP+AV	1msec	Auto	OFF	60dB

Transducer	No.	Start	Stop	Name
	1	9kHz	30MHz	CEB

Prescan Measurement: Detectors: X QP / + AV  
 Meas Time: see scan settings  
 Peaks: 8  
 Acc Margin: 25 dB

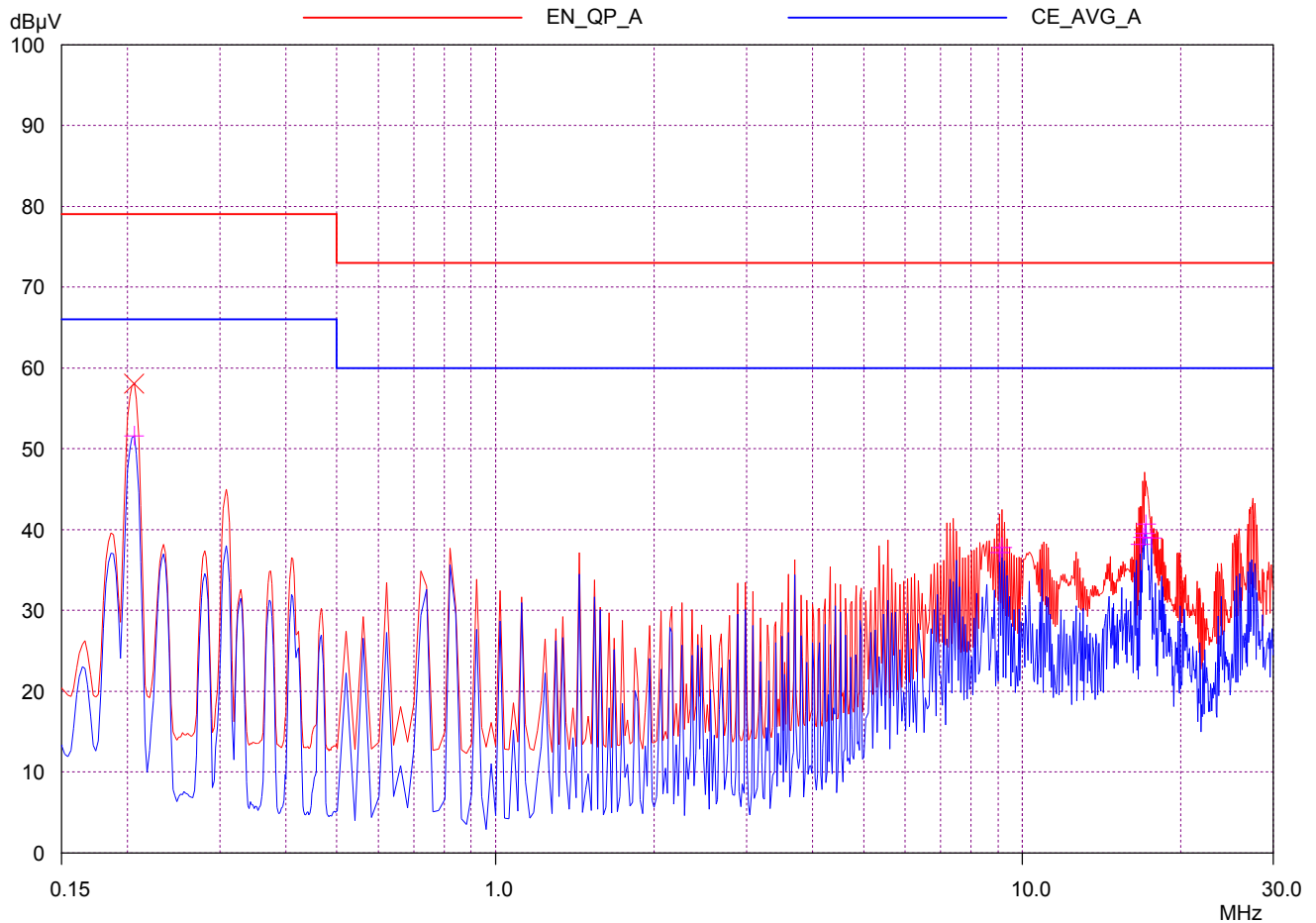

# ZIPPY EMC LAB

## conduction test

EUT: R1S2-5300V4H SPS  
 Manuf: ZIPPY TECH CO..LTD  
 Op Cond: FULL LOAD  
 Operator:  
 Test Spec: EN 55022-- Class A  
 Comment: Load Condition (16 11 0.5 11 2.5)  
 L220V

Scan Settings			(3 Ranges)		Receiver Settings			
Frequencies			IF BW	Detector	M-Time	Atten	Preamp	OpRge
Start	Stop	Step						
150kHz	500kHz	2kHz	10kHz	QP+AV	50msec	Auto	OFF	60dB
500kHz	5MHz	20kHz	10kHz	QP+AV	1msec	Auto	OFF	60dB
5MHz	30MHz	50kHz	10kHz	QP+AV	1msec	Auto	OFF	60dB

Transducer	No.	Start	Stop	Name
	1	9kHz	30MHz	CEB

Prescan Measurement: Detectors: X QP / + AV  
 Meas Time: see scan settings  
 Peaks: 8  
 Acc Margin: 25 dB

### Peak Search Results

Frequency MHz	QP Level dBµV	QP Limit dBµV	QP Delta dB	Phase	PE
0.206	58.04	79.00	20.96	N	gnd

Frequency MHz	AV Level dBµV	AV Limit dBµV	AV Delta dB	Phase	PE
0.206	51.58	66.00	14.42	N	gnd
9.05	37.15	60.00	22.85	N	gnd
9.15	37.76	60.00	22.24	N	gnd
16.75	38.18	60.00	21.82	N	gnd
16.95	39.01	60.00	20.99	N	gnd
17.05	39.50	60.00	20.50	N	gnd
17.15	40.65	60.00	19.35	N	gnd
17.6	38.94	60.00	21.06	N	gnd

\* limit exceeded

Indicated Phase/PE shows Configuration of max. Emission

# ZIPPY EMC LAB

## conduction test

EUT: R1S2-5300V4H SPS  
 Manuf: ZIPPY TECH CO..LTD  
 Op Cond: FULL LOAD  
 Operator:  
 Test Spec: EN 55022-- Class A  
 Comment: Load Condition (16 11 0.5 11 2.5)  
 N220V

Scan Settings (3 Ranges)			Receiver Settings					
Start	Stop	Step	IF BW	Detector	M-Time	Atten	Preamp	OpRge
150kHz	500kHz	2kHz	10kHz	QP+AV	50msec	Auto	OFF	60dB
500kHz	5MHz	20kHz	10kHz	QP+AV	1msec	Auto	OFF	60dB
5MHz	30MHz	50kHz	10kHz	QP+AV	1msec	Auto	OFF	60dB

Transducer	No.	Start	Stop	Name
	1	9kHz	30MHz	CEB

Prescan Measurement: Detectors: X QP / + AV  
 Meas Time: see scan settings  
 Peaks: 8  
 Acc Margin: 25 dB

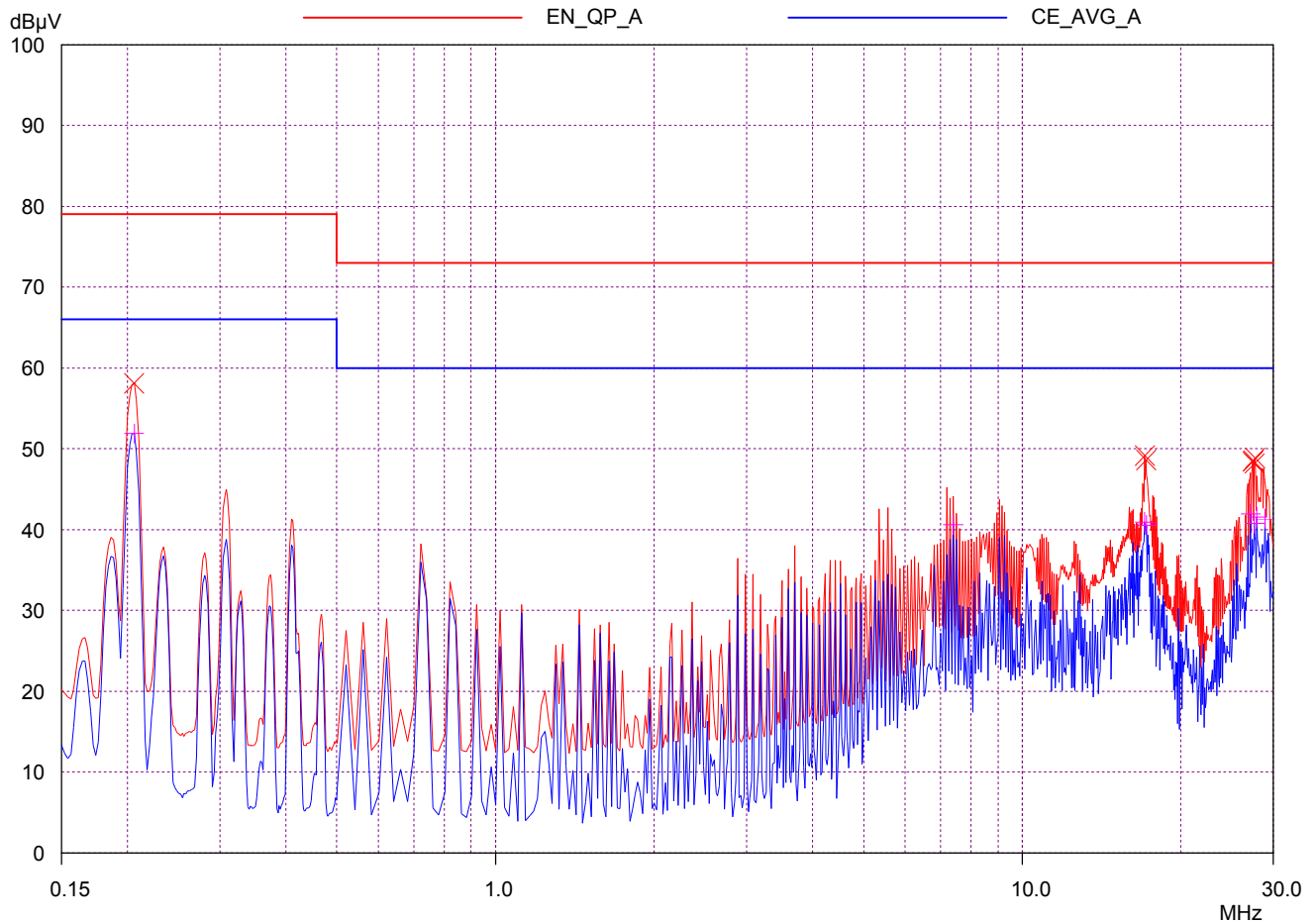

# ZIPPY EMC LAB

## conduction test

EUT: R1S2-5300V4H SPS  
 Manuf: ZIPPY TECH CO..LTD  
 Op Cond: FULL LOAD  
 Operator:  
 Test Spec: EN 55022-- Class A  
 Comment: Load Condition (16 11 0.5 11 2.5)  
 N220V

Scan Settings			(3 Ranges)		Receiver Settings			
Frequencies			IF BW	Detector	M-Time	Atten	Preamp	OpRge
Start	Stop	Step						
150kHz	500kHz	2kHz	10kHz	QP+AV	50msec	Auto	OFF	60dB
500kHz	5MHz	20kHz	10kHz	QP+AV	1msec	Auto	OFF	60dB
5MHz	30MHz	50kHz	10kHz	QP+AV	1msec	Auto	OFF	60dB

Transducer	No.	Start	Stop	Name
	1	9kHz	30MHz	CEB

Prescan Measurement: Detectors: X QP / + AV  
 Meas Time: see scan settings  
 Peaks: 8  
 Acc Margin: 25 dB

### Peak Search Results

Frequency MHz	QP Level dBµV	QP Limit dBµV	QP Delta dB	Phase	PE
0.206	58.08	79.00	20.92	N	gnd
17.05	49.13	73.00	23.87	N	gnd
17.15	48.59	73.00	24.41	N	gnd
27.35	48.39	73.00	24.61	N	gnd
27.45	48.51	73.00	24.49	N	gnd
27.55	48.17	73.00	24.83	N	gnd
27.65	48.83	73.00	24.17	N	gnd

Frequency MHz	AV Level dBµV	AV Limit dBµV	AV Delta dB	Phase	PE
0.206	51.84	66.00	14.16	N	gnd
7.4	40.55	60.00	19.45	N	gnd
17.05	40.93	60.00	19.07	N	gnd
17.2	40.53	60.00	19.47	N	gnd
27.15	41.95	60.00	18.05	N	gnd
27.55	40.74	60.00	19.26	N	gnd
27.85	41.53	60.00	18.47	N	gnd
28.9	41.30	60.00	18.70	N	gnd

\* limit exceeded

Indicated Phase/PE shows Configuration of max. Emission

## 3.2 Radiation Emission Test

### 3.2.1 Test Equipment

The following test equipment's are used during the radiated emission test :

Instrument	Manufacture	Type No:	Last Calibration
Spectrum Analyzer	H.P	8594A	May.,2015
Test Receiver	IFR System	A-7550	Jun.,2015
Preamplifier	H.P	8447D	May.,2015
Biconical Ant.	Emco	3110	Jun.,2015
Log-Periodic Ant.	Emco	3146	Jun.,2015
Dipole Antenna	Emco	3121C	May.,2015

### 3.2.2 Test Setup

#### 3.2.2.1 Block Diagram of Connection between EUT and simulators

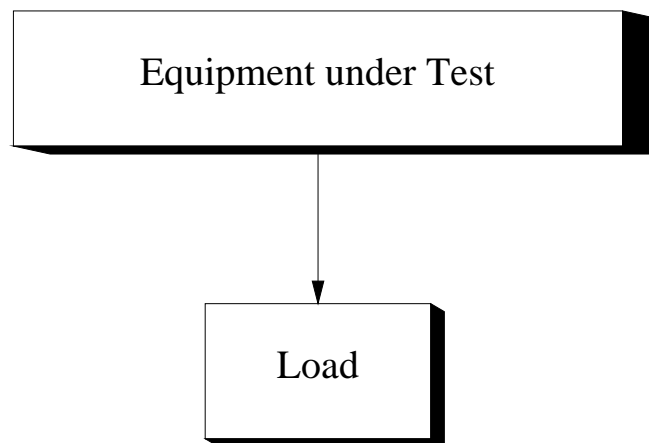

EUT: SWITCHING POWER SUPPLY

3.2.2.2 Open Field Test Site - description

The open field test site (OFTS) is designed to provide an environment in which repeatable tests of radiated emissions can be carried out.

It consists of a flat elliptical area as shown in the diagram below.

The equipment under test and the antenna are placed at the foci of the ellipse.

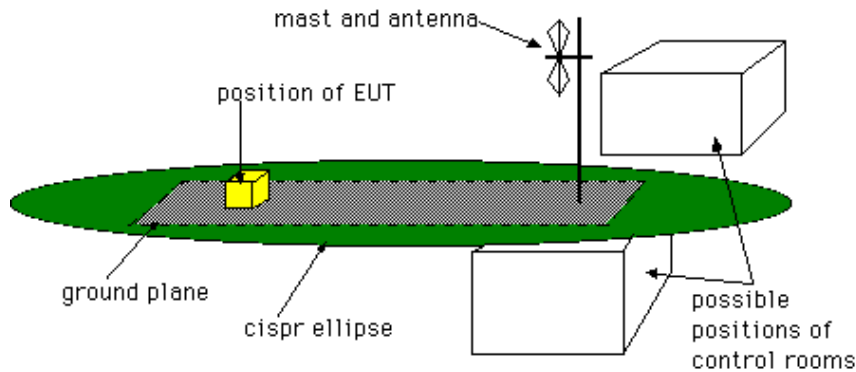

The antenna height should be remotely adjustable from 1m to 4m. Measuring instrumentation should be outside the ellipse at the position shown or in a room under the ground plane.

The whole or part of the site may be enclosed in an RF transparent building.

For precompliance testing a 3m test site with a fixed height antenna (at 1.5-2m height) and no metallic ground plane may be used. This may be a clear area on a car park or a grass area but should be away from large metallic structures.

3.2.3 Radiated Emission Limit

Class A Limits

Frequency	Distance	Field Strength
MHz	Meter	DB(uV/M)
30-230	10	40
230-1000	10	47

Remarks :

1. The tighter limit shall apply at the edge between two frequency bands.
2. Distance refers to the distance in meters between the measuring instrument antenna and the closed point of any part of the device or system.



### 3.2.4 EUT Configuration

The equipment's which is listed 4.2.1 are installed on Radiated Emission Test to meet the Commission requirement and operating in a manner which tends to maximize its emission characteristics in a normal application.

### 3.2.5 Operation Condition of EUT

Same as Conducted Power Line Test which is listed in 3.1.5 .

### 3.2.6 Radiated Emission Data

The measurement range of radiated emission which is from 30 MHz to 1000 MHz was investigated. The initial step in collecting conducted data is a spectrum analyzer peak scan of the measurement range for all the test modes. Then the worst modes were reported the following data pages.

Radiated Emission Data

EUT : SWITCH POWER SUPPLY TEMPERATURE : 26°C

TEST MODE : R1S2-5300V4H HUMIDITY : 57%

Frequency (MHz)	Emission Level	Limits dBuV/m	Remark
	Horizontal dBuV/m		
90.14	11.59	40.00	
258.92	13.78	47.00	
588.72	19.65	47.00	
621.70	20.03	47.00	
891.36	23.22	47.00	
1000.00	23.52	47.00	

Radiated Emission Data

EUT : SWITCH POWER SUPPLY TEMPERATURE : 26°C

TEST MODE : R1S2-5300V4H HUMIDITY : 57%

Frequency (MHz)	Emission Level	Limits dBuV/m	Remark
	Vertical dBuV/m		
33.88	19.16	40.00	
90.14	24.93	40.00	
272.50	24.52	47.00	
538.28	17.76	47.00	
774.96	24.25	47.00	
887.48	22.85	47.00	

### Horizontal Curve

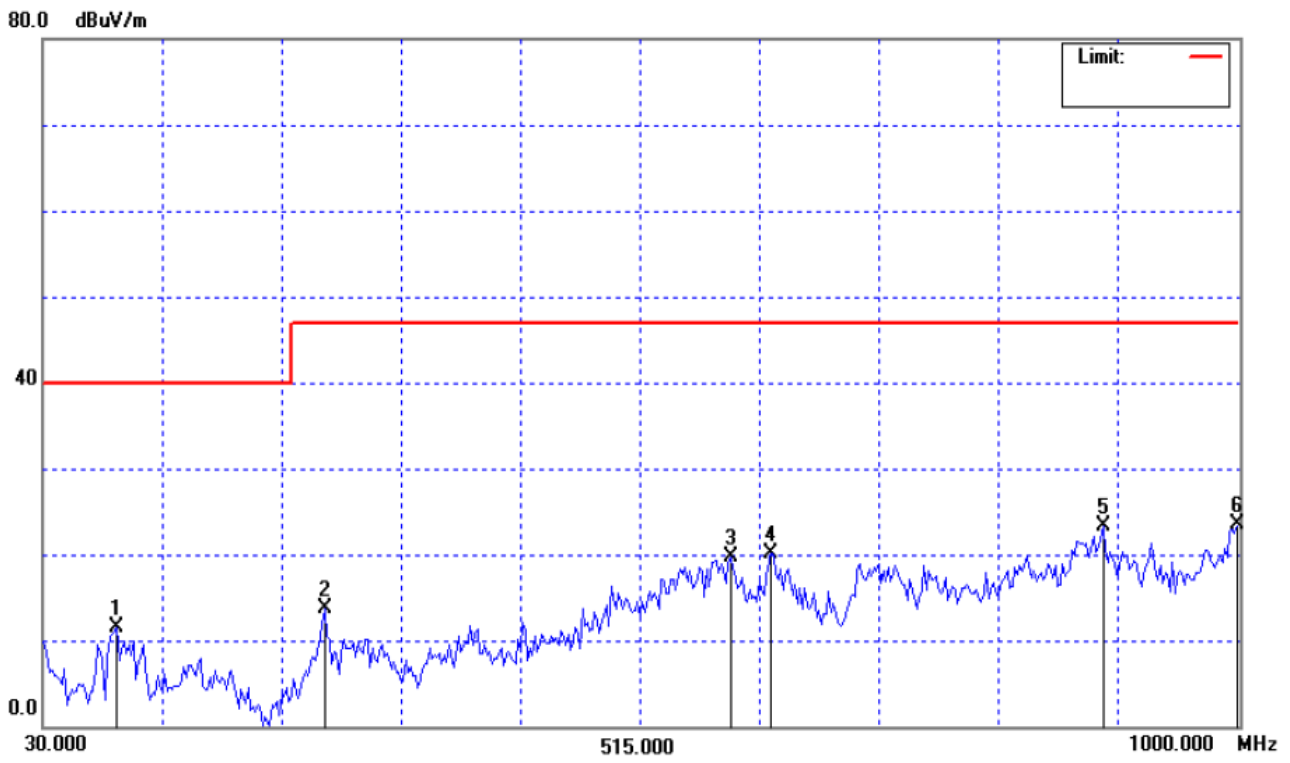

### Vertical Curve

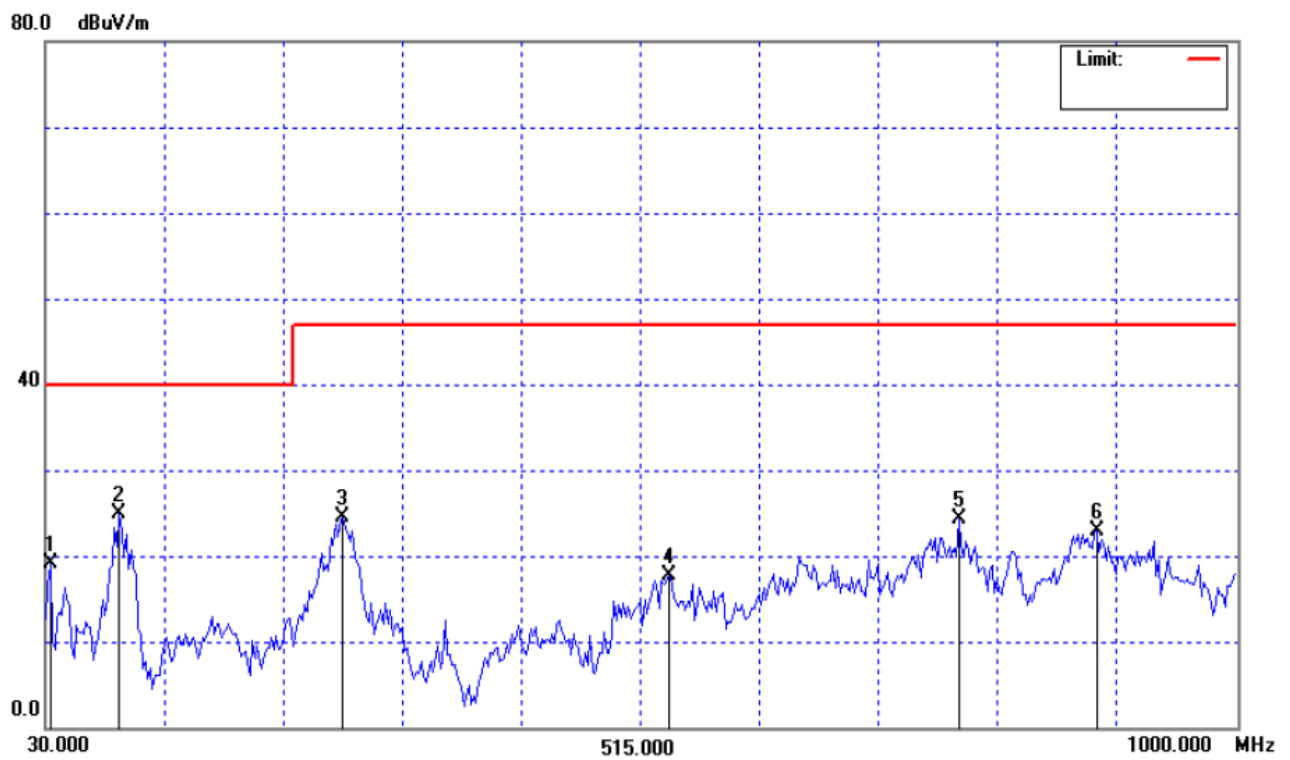

### 3.2.7 Test Photo and Setup

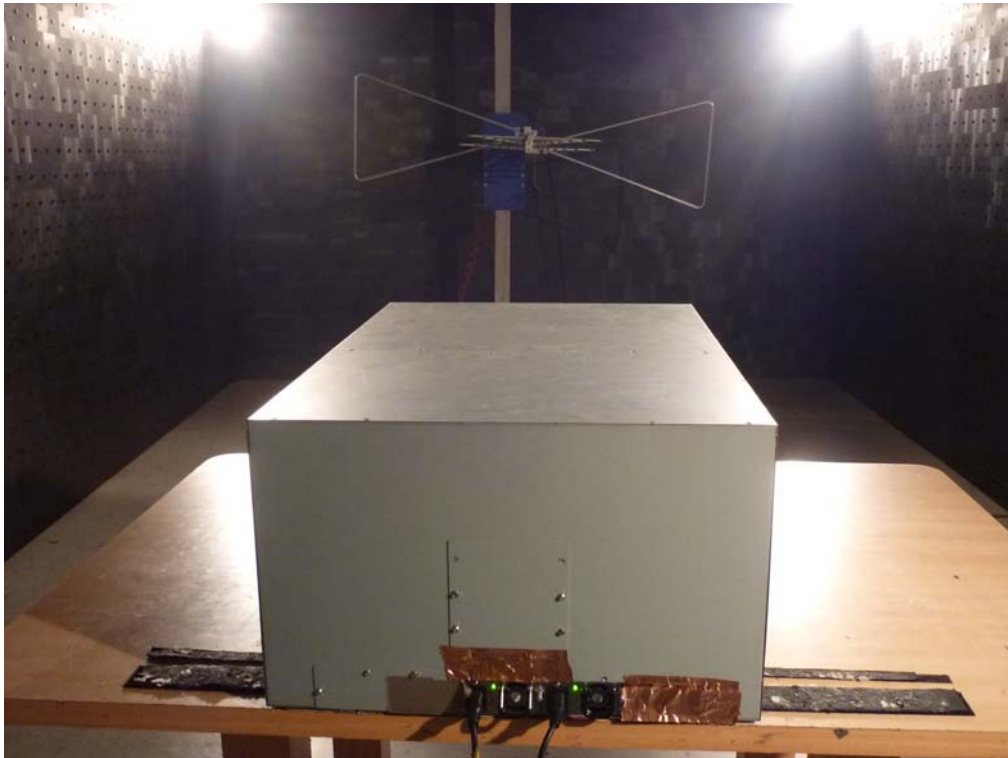

※During the radiated test, the power-supply has to test with chassis, which is not allowed to be operated stand-alone. (For user, final assembly has to comply with corresponding EMC-and safety-regulations.)

## 4. ESD Measurement

### 4.1 Test Equipment

The following test equipment's are used during the ESD test :

Instrument	Manufacture	Type No:	Last Calibration
ESD Simulator system	Keytek	MZ-15/EC	May.,2015
Electronic Load	D-RAM	Load-2000	N/A

### 4.2 Test Setup

#### 4.2.1 Block Diagram of Connections between EUT and simulators

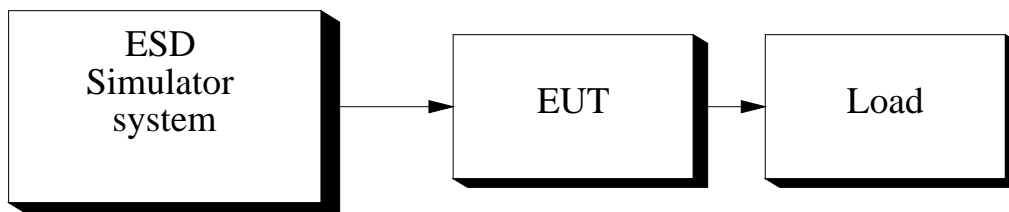

#### 4.2.2 Test Setup of EUT

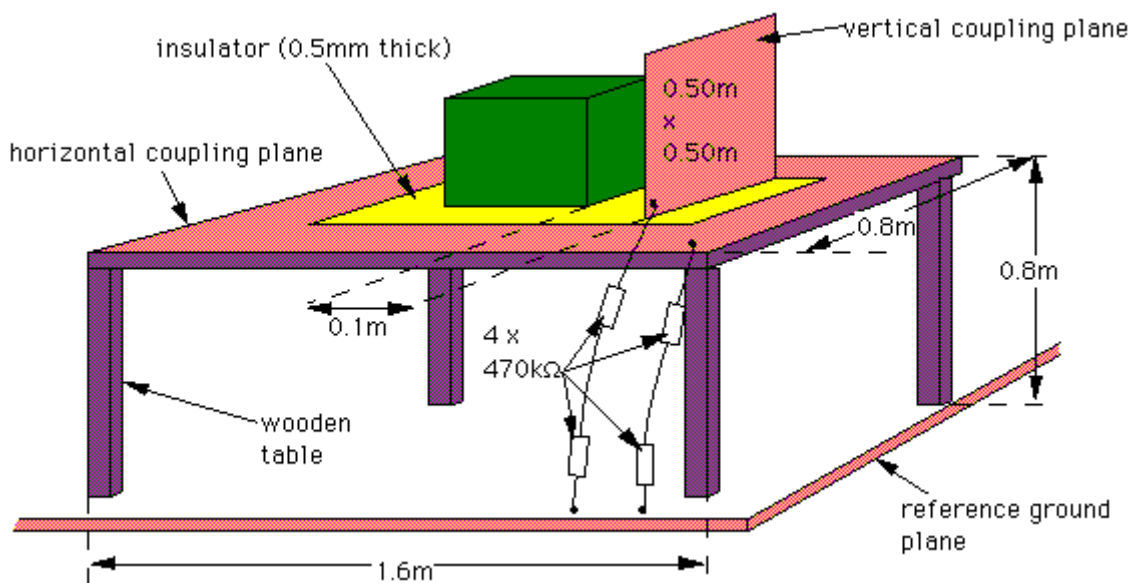

### 4.3 Severity Levels

LEVEL	TEST VOLTAGE CONTACT DISCHARGE	TEST VOLTAGE AIR DISCHARGE
1	2KV	2KV
2	4KV	4KV
3	6KV	6KV
4	8KV	8KV
X	SPECIAL	SPECIAL

### 4.4 EUT Operating Condition

1. Setup the EUT and Test Equipment as shown on 4.2
2. power on.

### 4.5 Test Procedure

Air Discharge:

This test was done above a non-conductive surfaces. The round discharge electrode about 30cm away will approach as fast as possible to touch test points of the EUT. Discharge happens before the contact. This procedure is repeated ten times on one selected location.

### 4.6 Test Method

According to IEC 61000-4-2

## 4.7 Test Result

EUT : SWITCH POWER SUPPLY TEMPERATURE : 26°CTEST MODE : R1S2-5300V4H HUMIDITY : 65%

Item	Amount of discharge	Voltage	Results
Contact discharge	500	+2KV -2KV	Pass Pass
Contact discharge	500	+4KV -4KV	Pass Pass
Air discharge	500	+2KV -2KV	Pass Pass
Air discharge	500	+4KV -4KV	Pass Pass
Air discharge	500	+6KV -6KV	Pass Pass
Air discharge	500	+8KV -8KV	Pass Pass

※Input Voltage / Frequency : 230Vac/50Hz



## 5. Radiated Susceptibility Measurement

### 5.1 Test Equipment

The following test equipment's are used during the RS test :

Instrument	Manufacture	Type No:	Last Calibration
Signal generator	H.P	8657A	Dec.,2015
Power amplifier	A&R	100A100	Dec.,2015
Field strength meter	A&R	FM2000	Oct.,2015
Field strength sensor	A&R	EP2000	Oct.,2015
Power antenna	A&R	AT1080	Oct.,2015

### 5.2 Block Diagram of Test Setup

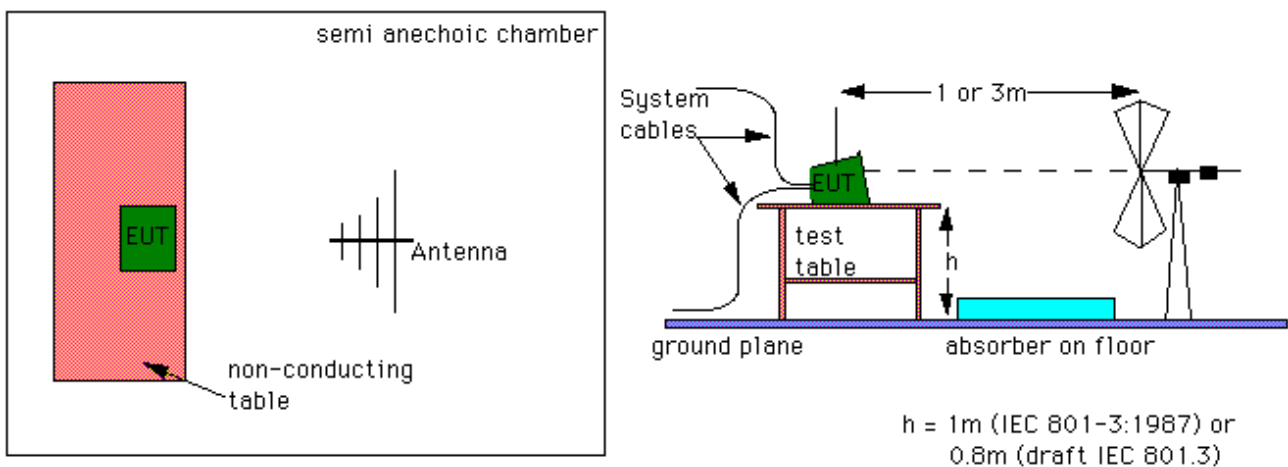

Antennas-layout

For the upper frequency range of 200 to 1000 MHz, antennas are the normal method of producing the required field strength. This is also carried out in an anechoic chamber or a screened room. If a screened room is used it must be damped. The anechoic chamber should be used for compliance testing, the screened room may be used for precompliance testing. The fields in the screened room will not be as uniform as those obtainable in an anechoic chamber and will also not be as repeatable. The EUT is placed on a non-conductive table, 0.8 m above the reference ground plane, which in many cases will be the floor of a screened room. According to the standards, the EUT should be oriented so that its most sensitive side is facing the antenna. In practice it can be difficult to decide beforehand which is the most sensitive side, and in most cases, a series of tests will be required with the EUT in several orientations.

### 5.3 Severity Levels

LEVEL	FIELD STRENGTH V/M
1	1
2	3
3	10
X	SPECIAL

### 5.4 EUT Operating Condition

Same as section 4.4.

### 5.5 Test Procedure

The EUT and load are placed on a table which is 0.8 meter above ground. The field sensor is also placed on the same table to monitor field strength from transmitting antenna.

EUT is set 1 meter away from the transmitting antenna which is mounted on an antenna each time.

The antenna is fixed 1 meter above ground. Both horizontal and vertical polarization of the antenna are set on measurement. In order to judge the EUT performance, a CCD camera is used to monitor EUT screen.

All the scanning conditions are as follows :

Condition of Test	Remarks
1. Field Strength	3 V/M Level 2
2. Radiated Signal	80% Amplitude Modulated with a 1KHz Tone
3. Scanning Frequency	80 MHz-1 GHz
4. Sweep Time of Radiated	0.0015 Decade/s

### 5.6 Test Method

According to IEC 61000-4-3

## 5.7 Test Result

EUT : SWITCH POWER SUPPLY TEMPERATURE : 26°C

TEST MODE : R1S2-5300V4H HUMIDITY : 65%

Frequency Range (MHz)	Position (Angle)	Polarity (HorV)	Field Strength (V/M)	Results
80-1000	0° (Front)	H	3	Pass
80-1000	90° (Right)	H	3	Pass
80-1000	180° (Back)	H	3	Pass
80-1000	270° (Left)	H	3	Pass
80-1000	0° (Front)	V	3	Pass
80-1000	90° (Right)	V	3	Pass
80-1000	180° (Back)	V	3	Pass
80-1000	270° (Left)	V	3	Pass

Test Result : Criteria A

## 6. Electrical Fast Transient / Burst Measurement

### 6.1 Test Equipment

The following test equipment's are used during the EFT tests :

Instrument	Manufacturer	Type No.	Last Calibration
Fast Transient / Burst enerator	Keytek	EMCpro	May.,2015

### 6.2 Block Diagram of Test Setup

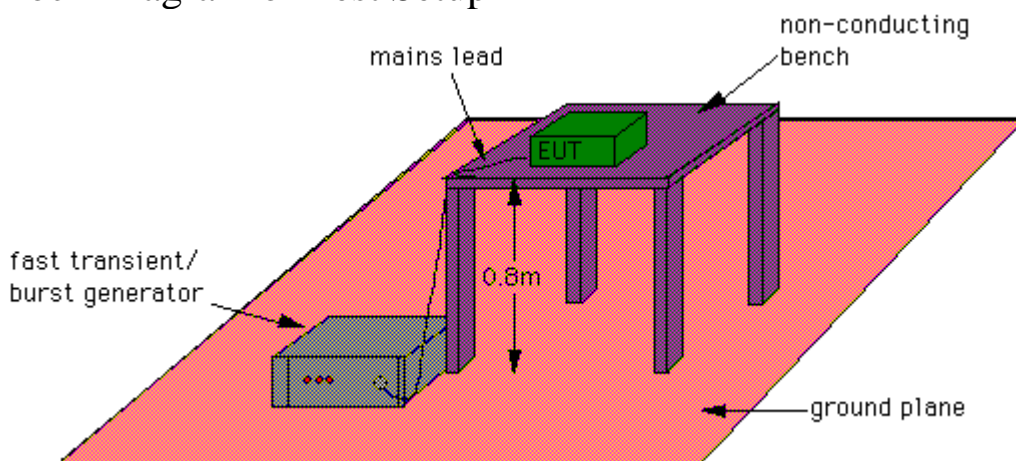

### 6.3 Severity Levels

Open Circuit Output Test Voltage $\pm 10\%$	
Level	On power supply lines
1	0.5KV
2	1KV
3	2KV
4	4KV
X	SPECIAL

## 6.4 EUT Operation Condition

Same as section 4.4.

## 6.5 Test Procedure

The EUT and its load are placed on a table which is 0.8 meter above a metal ground plane measured 1m\*1m min. And 0.65 mm thick min. And projected beyond the EUT by at least 0.1m on all sides.

The EUT is away from the walls of the test AC power line test is as follows:

For Ac power line test:

The EUT is connected to the power mains through a coupling device that directly couples the EFT interference signal.

Each of the Line and Neutral conductor is impressed with burst noise for 1 min.

## 6.6 Test Method

According to IEC 61000-4-4.

## 6.7 Test Result

EUT : SWITCH POWER SUPPLY TEMPERATURE : 26°C

TEST MODE : R1S2-5300V4H HUMIDITY : 65%

Inject Line	Voltage KV	Frequency (KHz)	Inject time (sec)	Inject Method	Result
L1	±1	5	60	Direct	Pass
L2	±1	5	60	Direct	Pass
PE	±1	5	60	Direct	Pass
L1-L2	±1	5	60	Direct	Pass
L1-PE	±1	5	60	Direct	Pass
L2-PE	±1	5	60	Direct	Pass
L1,L2-PE	±1	5	60	Direct	Pass

※Input Voltage / Frequency : 230Vac/50Hz

## 7. Harmonic Current Test

EUT : SWITCH POWER SUPPLY      TEMPERATURE : 26°C

TEST MODE : R1S2-5300V4H      HUMIDITY : 65%

Item	Reading Leve A		Item	Reading Leve A	
	A	Limites		A	Limites
1	1.6732				
3	0.0744	1.2709			
5	0.0942	0.7102			
7	0.0808	0.3738			
9	0.0577	0.1869			
11	0.0377	0.1308			
13	0.0354	0.1107			
15	0.0254	0.0959			
17	0.0440	0.0847			
19	0.0251	0.0757			
21	0.0071	0.0685			
23	0.0140	0.0626			
25	0.0213	0.0576			
27	0.0264	0.0533			
29	0.0177	0.0496			
31	0.0070	0.0464			
33	0.0049	0.0436			
35	0.0113	0.0411			
37	0.0094	0.0389			
39	0.0058	0.0369			



ANALYZER 6630

### Current Harmonics

Setup: CLASS\_D    Gen setting: 1(1)    U : 230.14 V    fu: 50.001 Hz  
 Live            Analysed periods: 4    I : 1.6829 A    P: 373.8 W  
 Module: M1      Limit: Class D (User def)    I1: 1.6732 A  
 Note:  
 THD=10.72 % (PF=0.965)    PASSED

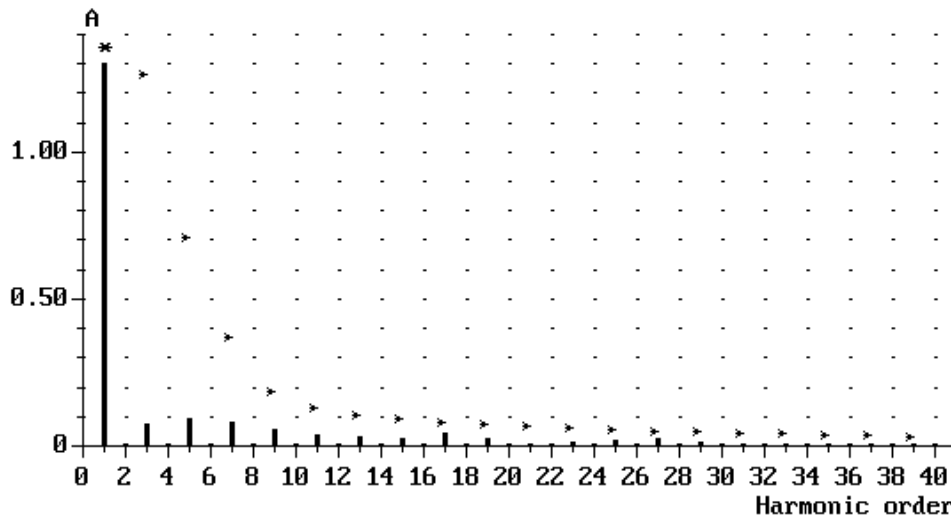

Appl: EUROPE

Next measure

Change to table

Relative current

Log scale

Write to disk



(1212\_00)



ANALYZER 6630

### Current Harmonics

Setup: CLASS\_D    Gen setting: 1(1)    U : 230.14 V    fu: 50.001 Hz  
 Live            Analysed periods: 4    I : 1.6829 A    P: 373.8 W  
 Module: M1      Limit: Class D (User def)    I1: 1.6732 A  
 Note:  
 THD=10.72 % (PF=0.965)    PASSED

No	A	Lim A	No	A	Lim A	No	A	Lim A
1	1.6732		15	0.0254	0.0959	29	0.0177	0.0496
2	0.0008		16	0.0001		30	0.0002	
3	0.0744	1.2709	17	0.0440	0.0847	31	0.0070	0.0464
4	0.0004		18	0.0001		32	0.0002	
5	0.0942	0.7102	19	0.0251	0.0757	33	0.0049	0.0436
6	0.0004		20	0.0002		34	0.0002	
7	0.0008	0.3738	21	0.0071	0.0685	35	0.0113	0.0411
8	0.0002		22	0.0003		36	0.0001	
9	0.0577	0.1869	23	0.0140	0.0626	37	0.0094	0.0389
10	0.0002		24	0.0003		38	0.0002	
11	0.0377	0.1308	25	0.0213	0.0576	39	0.0058	0.0369
12	0.0004		26	0.0001		40	0.0003	
13	0.0354	0.1107	27	0.0264	0.0533			
14	0.0003		28	0.0002				

Current range: 3 Ap

Appl: EUROPE

Next measure

Change to bar graph

Relative current

Write to disk



(1212\_01)



### 8. Voltage Fluctuation And Flicker Test

EUT : SWITCH POWER SUPPLY TEMPERATURE : 26°C

TEST MODE : R1S2-5300V4H HUMIDITY : 65%

Item	Reading	Limit	Result
Pst	0.000	1.00	Pass
P1t	0.000	0.65	Pass
Dc (%)	0.000	3.00	Pass
Dmax (%)	0.000	4.00	Pass
Dt (%)	0.000	0.20	Pass

## 9. Surge Immunity Test

EUT : SWITCH POWER SUPPLY TEMPERATURE : 26°C

TEST MODE : R1S2-5300V4H HUMIDITY : 65%

Waveform	Voltage	Output:LC	Phs Ref	Phs Ang	Tests	Delay	Result
12 Ohm	-2000V	MAINS:L1/PE	L1	0 deg.	5	60 sec	Pass
12 Ohm	-2000V	MAINS:L1/PE	L1	90 deg.	5	60 sec	Pass
12 Ohm	-2000V	MAINS:L1/PE	L1	270 deg.	5	60 sec	Pass
12 Ohm	2000V	MAINS:L1/PE	L1	0 deg.	5	60 sec	Pass
12 Ohm	2000V	MAINS:L1/PE	L1	90 deg.	5	60 sec	Pass
12 Ohm	2000V	MAINS:L1/PE	L1	270 deg.	5	60 sec	Pass
12 Ohm	-2000V	MAINS:L2/PE	L1	0 deg.	5	60 sec	Pass
12 Ohm	-2000V	MAINS:L2/PE	L1	90 deg.	5	60 sec	Pass
12 Ohm	-2000V	MAINS:L2/PE	L1	270 deg.	5	60 sec	Pass
12 Ohm	2000V	MAINS:L2/PE	L1	0 deg.	5	60 sec	Pass
12 Ohm	2000V	MAINS:L2/PE	L1	90 deg.	5	60 sec	Pass
12 Ohm	2000V	MAINS:L2/PE	L1	270 deg.	5	60 sec	Pass
2 Ohm	-1000V	MAINS:L1/L2	L1	0 deg.	5	60 sec	Pass
2 Ohm	-1000V	MAINS:L1/L2	L1	90 deg.	5	60 sec	Pass
2 Ohm	-1000V	MAINS:L1/L2	L1	270 deg.	5	60 sec	Pass
2 Ohm	1000V	MAINS:L1/L2	L1	0 deg.	5	60 sec	Pass
2 Ohm	1000V	MAINS:L1/L2	L1	90 deg.	5	60 sec	Pass
2 Ohm	1000V	MAINS:L1/L2	L1	270 deg.	5	60 sec	Pass

## 10. Conducted Immunity Test

EUT : SWITCH POWER SUPPLY TEMPERATURE : 26°C

TEST MODE : R1S2-5300V4H HUMIDITY : 65%

Test frequency Range : 150kHz ~ 80MHz

Frequency Step : 1% of the momentary frequency

Dwell Time : Minimum 3 sec. per frequency

Modulation : 1kHz Sine Wave with 80% Amplitude Modulation

Frequency Range (MHz)	Polarity (HorV)	Field Strength (V/M)	Performance		Result
			Required	Observation	
0.15-80	H	3	A	A	Pass

## 11. Voltage Dip, Interruptions Immunity Test

EUT : SWITCH POWER SUPPLY TEMPERATURE : 26°C

TEST MODE : R1S2-5300V4H HUMIDITY : 65%

Test Voltage	Phase Angle	Reduction %	Duration (Periods)	Performance		Result
				Required	Observation	
AC 115V	0 deg.	>95%	0.5	B	A	Pass
	90 deg.		0.5	B	A	Pass
	180 deg.		0.5	B	A	Pass
	270 deg.		0.5	B	A	Pass
	0 deg.	30%	25	C	A	Pass
	90 deg.		25	C	A	Pass
	180 deg.		25	C	A	Pass
	270 deg.		25	C	A	Pass
	0 deg.	>95%	250	C	C	Pass
	90 deg.		250	C	C	Pass
	180 deg.		250	C	C	Pass
	270 deg.		250	C	C	Pass
AC 230V	0 deg.	>95%	0.5	B	A	Pass
	90 deg.		0.5	B	A	Pass
	180 deg.		0.5	B	A	Pass
	270 deg.		0.5	B	A	Pass
	0 deg.	30%	25	C	A	Pass
	90 deg.		25	C	A	Pass
	180 deg.		25	C	A	Pass
	270 deg.		25	C	A	Pass
	0 deg.	>95%	250	C	C	Pass
	90 deg.		250	C	C	Pass
	180 deg.		250	C	C	Pass
	270 deg.		250	C	C	Pass

## 12. Power Frequency Magnetic Field (PFM) Immunity Test

EUT : SWITCH POWER SUPPLY TEMPERATURE : 26°C

TEST MODE : R1S2-5300V4H HUMIDITY : 65%

Magnetic Field Orientation	Magnetic Field (A/m)	Performance		Result (Pass/Fail)
		Required	Observation	
X-axis	1A	A	A	Pass
Y-axis	1A	A	A	Pass
Z-axis	1A	A	A	Pass

### 13. Photographs

- 1.Front view of Power Supply
- 2.Back view of Power Supply



3.Front view of Power Supply

4.Back view of Power Supply



5.Component side of Mainboard

6.Solder side of Mainboard

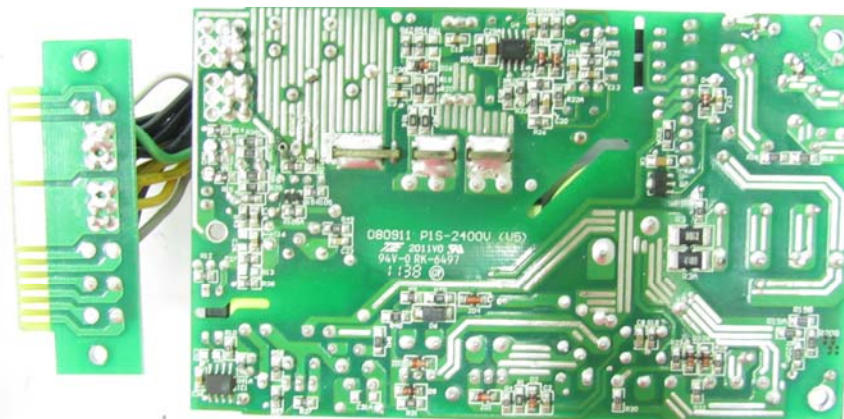
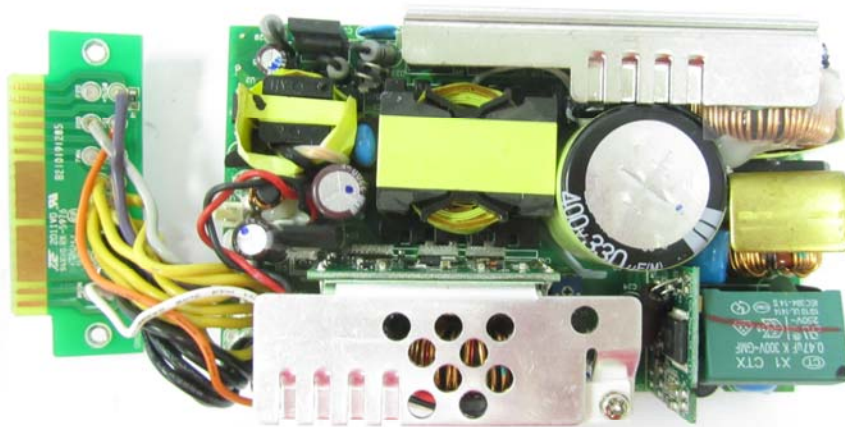



7.Component side of Mainboard

8.Solder side of Mainboard

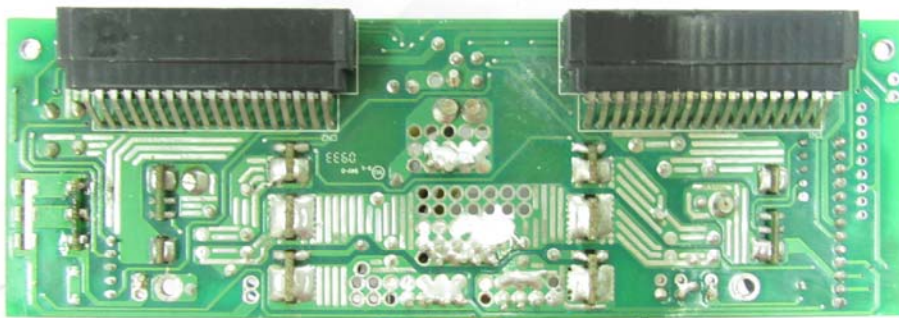
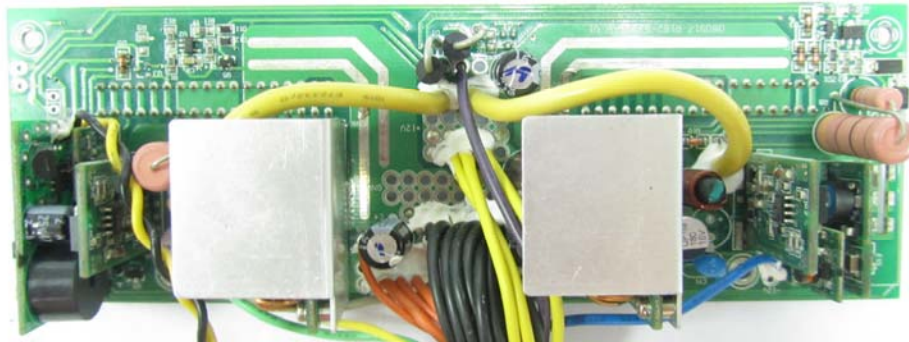

- 9. Inside view of Power Supply
- 10. Inside view of Power Supply



11. Inside view of Power Supply

12. Test view

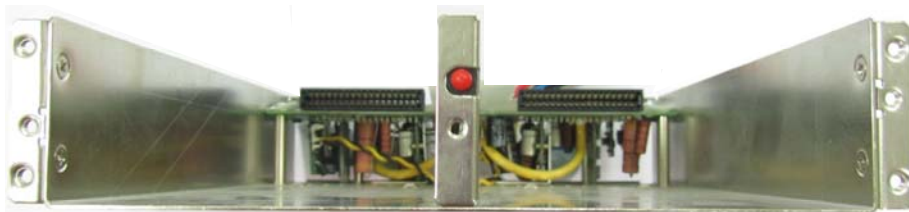

## **14. EMI Reduction Method During Compliance Testing**

1.No modification was made during test.